

USER MANUAL **TRSYS20**

High-accuracy building thermal resistance measuring system with two measurement locations

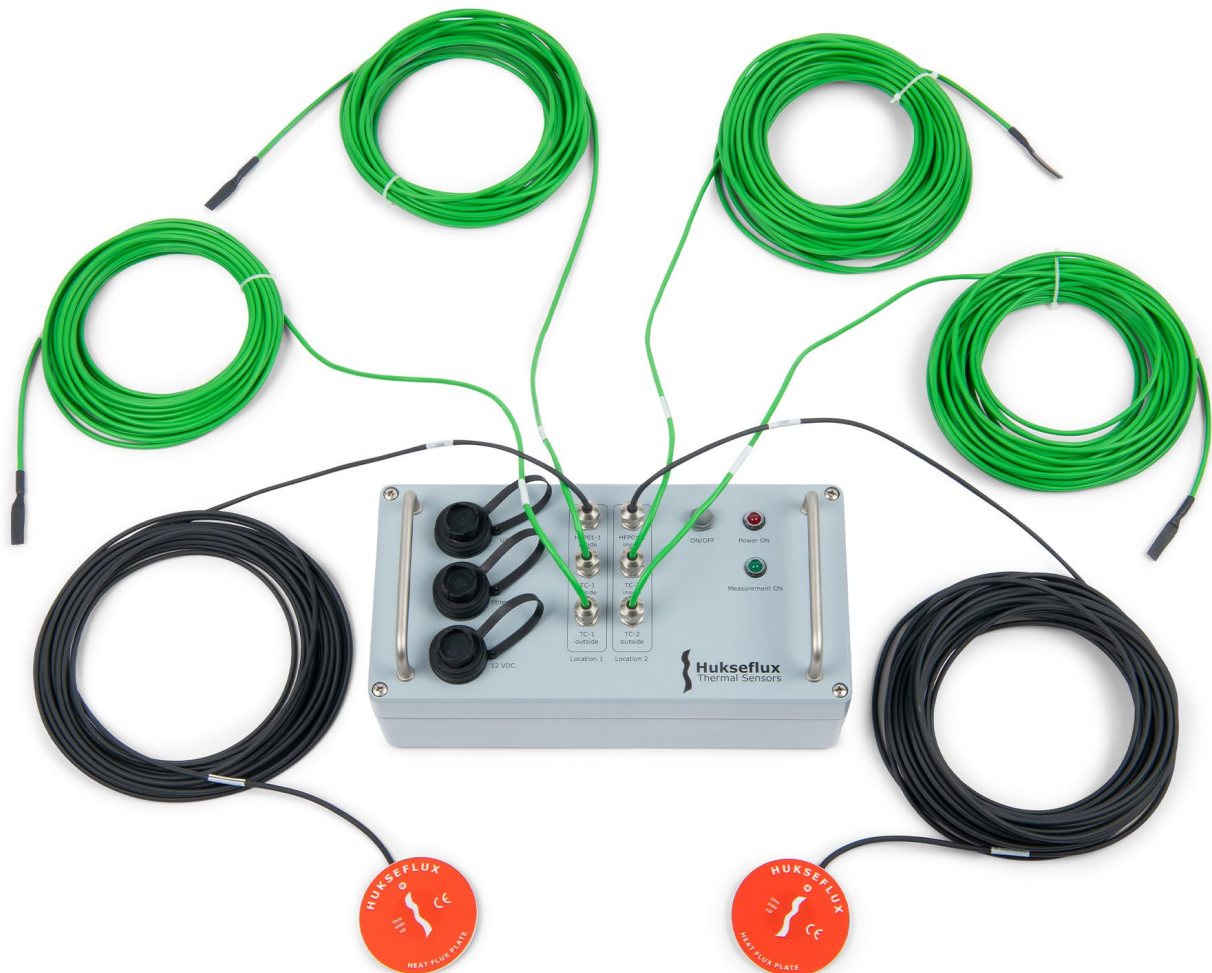

Cautionary statements

Cautionary statements are subdivided into four categories: danger, warning, caution and notice according to the severity of the risk.

 DANGER
Failure to comply with a danger statement will lead to death or serious physical injuries.

 WARNING
Failure to comply with a warning statement may lead to risk of death or serious physical injuries.

 CAUTION
Failure to comply with a caution statement may lead to risk of minor or moderate physical injuries.

NOTICE
Failure to comply with a notice may lead to damage to equipment or may compromise reliable operation of the instrument.

Contents

Cautionary statements	2
Contents	3
List of symbols	4
Introduction	5
1 Ordering and checking at delivery	10
1.1 Ordering TRSYS20	10
1.2 Included items	10
2 Instrument principle and theory	11
2.1 TRSYS20 measuring system	11
2.2 Theory	12
3 Specifications of TRSYS20	17
3.1 Specifications of TRSYS20	17
3.2 Dimensions of TRSYS20	21
4 Preparation of an experiment	22
4.1 Preparing the equipment	22
5 TRSYS20 MCU system setup	23
5.1 Setting up connection	23
5.2 Setting the clock	24
5.3 Setting the net frequency filter	25
5.4 Verifying the programmed HFP01 sensitivity	25
6 Installation of sensors: HFP01 and TC	26
6.1 Site selection and installation	26
7 Performing measurements	29
7.1 Starting an experiment	29
7.2 Monitoring measurements	29
7.3 Retrieving measurement data	30
8 Data analysis tool	31
8.1 Importing the data	31
8.2 Viewing results	31
9 Uncertainty evaluation	32
9.1 Heat flux measurements	32
9.2 Temperature difference	32
9.3 Thermal resistance	32
10 Maintenance and trouble shooting	33
10.1 Recommended maintenance and quality assurance	33
10.2 Trouble shooting	34
10.3 Calibration and checks in the field	35
10.4 Storage	35
11 Appendices	36
11.1 TRSYS20 data table	36
11.2 EU declaration of conformity	37

List of symbols

Quantities	Symbol	Unit
Heat flux	Φ	W/m ²
Voltage output	U	V
Sensitivity	S	V/(W/m ²)
Temperature	T	°C
Temperature difference	ΔT	°C, K
Time constant	τ	s
Thermal resistance, from surface to surface	R	K/(W/m ²)
Thermal resistance, from environment to environment	R _T	K/(W/m ²)
Λ -Value, thermal conductance	Λ	W/(m ² ·K)
Thermal resistance ambient air boundary layer for:		
indoor layer	R _{amb., indoor}	K/(W/m ²)
outdoor layer	R _{amb., outdoor}	K/(W/m ²)
U-Value, thermal transmittance	U	W/(m ² ·K)
Time	t	s
Thermal conductivity	λ	W/(m·K)
Thermal resistivity	r	m·K/W
Ambient air / wind speed	v	m/s
Volumetric heat capacity	C _{volumetric}	J/(m ³ ·K)
Resistance	R	Ω
Heat transfer coefficient	h	W/(m ² ·K)
Convection heat transfer coefficient	h _c	W/(m ² ·K)
Radiation heat transfer coefficient	h _r	W/(m ² ·K)

Subscripts

Property of thermopile sensor	sensor
Property of ambient air	ambient
Property at indoor location	indoor
Property at outdoor location	outdoor

Acronyms

GUI	Graphical User Interface
MCU	Measurement Control Unit
PC	Personal Computer
PSU	Power Supply Unit
ISO	International Organization for Standards
ASTM	American Society for Testing and Materials
TC	Thermocouple
HFM	heat flow meter (ISO)
HFT	heat flow transducer (ASTM)

Introduction

TRSYS20 is a high-accuracy system for on-site measurement of thermal resistance (R-value), and thermal transmittance (U-value), of building envelope components. TRSYS20 is mostly used for measurements according to standard practices of ISO 9869 and ASTM C1155 / C1046. The system is equipped with high-accuracy electronics, two heat flux sensors of model HFP01 as well as two pairs of matched thermocouples. The two measurement locations provide redundancy, leading to a high level of confidence in the measurement result. The high accuracy of the heat flux sensors and temperature difference measurements ensures that TRSYS20 continues measuring when other systems no longer perform; in particular at very low temperature differences across the wall.

HFP01 is a versatile heat flux sensor that, amongst others, has been employed in soil science applications for studying the heat balance of soils and in building physics applications for determining the thermal resistances of walls and building envelope components. For HFP01 specifications, see the [HFP01](#) manual.

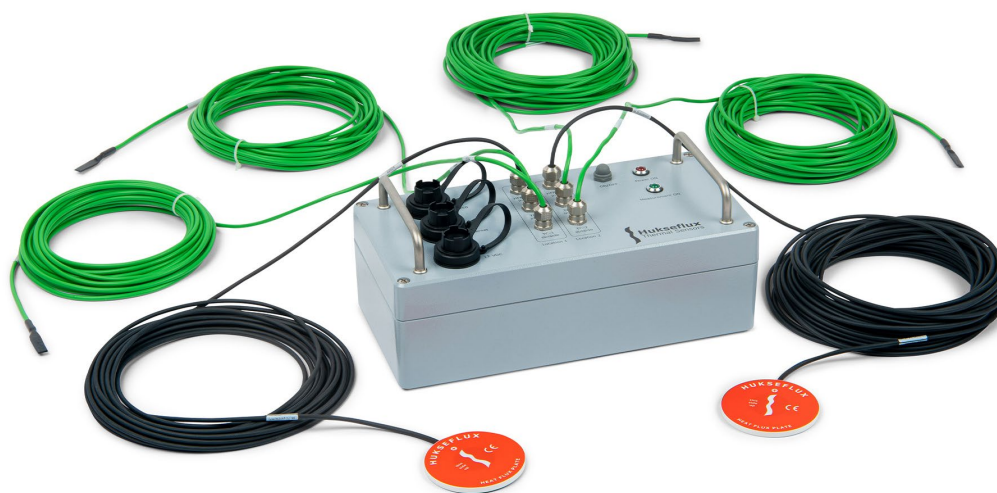

Figure 0.1 TRSYS20: the complete measuring system includes 2 HFP01 heat flux sensors and 2 matched thermocouple pairs, TC, (in total 4 temperature sensors) and the MCU measurement and control unit.

On-site measurements of thermal resistance, R , are often applied in studies of buildings. Alternatives are to measure its inverse value, the thermal conductance which is called the Λ -value, or the thermal transmittance which includes ambient air boundary layer thermal resistance, the U-value.

The measurements of R are based on simultaneous time averaged measurement of heat flux Φ and differential temperature, ΔT , (using two temperature sensors, each on a different side of the wall).

$$R = \Delta T / \Phi$$

The ISO and ASTM standards give detailed directions concerning the measurement method, sensor installation and data analysis.

The TRSYS20 system employs dedicated sensors and electronics. Their high sensitivity and accuracy ensure that TRSYS20 will still measure under circumstances where competing systems no longer perform reliable measurements; i.e. down to very low heat fluxes and low temperature differences across the wall. The matched thermocouple pairs in TRSYS20, measure temperature differences with an uncertainty of better than 0.1 °C over the entire rated temperature range. TRSYS20 includes 2 x HFP01 heat flux plates. HFP01 is the world's most popular sensor for heat flux measurement in studies of buildings.

The system generates a measurement file, including time, heat flux, temperature and temperature difference for the two measurement locations. The measurement is stored in the MCU and later downloaded to a PC. The user is responsible for data analysis, calculating the R-value or U-value of the building envelope according to the ISO or ASTM standards.

Equipped with heavy-duty components, TRSYS20 has proven to be very robust and stable. It survives repeated installation necessary in this application where measuring systems are typically used at multiple locations.

The measurements and the analyses that have to be performed are not straightforward; although the measurements are standardised, this always involves a significant element of expertise and a subjective data interpretation. Hukseflux helps to gain the necessary experience by offering operator training.

Training vastly improves the level of service to the end user, the efficiency of working with the equipment and reduces the uncertainty of the end result. Please [contact](#) us for more information on training courses in thermal measurement at Hukseflux.

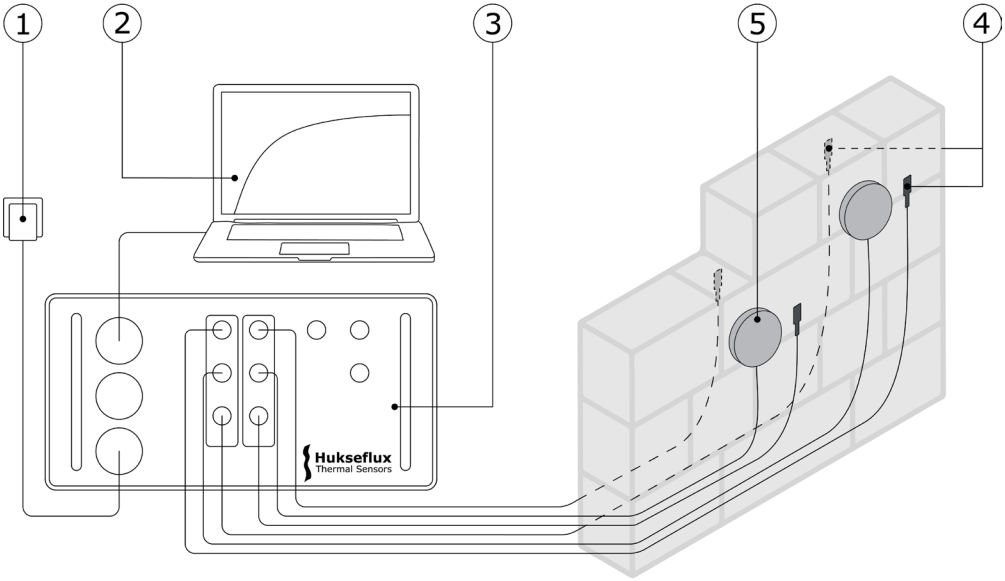

Figure 0.2 TRSYS20 consists of MCU Measurement and Control Unit (3), a 12 VDC adapter to power the MCU (1), two pairs of matched thermocouples (4) to be placed on both sides of a wall, and two model HFP01 heat flux plates (5) to be placed on the inside side of a wall. The MCU measures and stores measurement data. The MCU can be

connected to a PC (2, not included) via USB or ethernet. Graphical user interface is accessible through a web browser.

Calibration of TRSYS20 components is traceable to international standards. HFP01 and MCU are traceable to the international standards for voltage, current and length, the thermocouples to ITS-90. TRSYS20 undergoes a functional test at the factory. This conformity assessment includes temperature difference measurement accuracy.



Figure 0.3 TRSYS20 in its carrying case on the left and one HFP01 sensor on the right. 2 HFP01 heat flux sensors and 2 matched thermocouple pairs, TC, (in total 4 temperature sensors) are included in TRSYS20.

TRSYS20 advantages

- **Connection via ethernet or USB.** The MCU can be connected to a local area network (LAN) via ethernet or directly to a PC via USB.
- **Intuitive and easy-to-use graphical user interface.** The MCU acts as a server that provides a graphical user interface in the form of a webpage. The graphical user interface is accessible through a web browser. No software installation is required.
- **Matched thermocouple pairs.** Matched thermocouple pairs have a measurement uncertainty of better than 0.1 °C over the entire rated temperature range. Their high accuracy and sensitivity ensure that TRSYS20 will still measure under circumstances where competing systems no longer perform reliable measurements; i.e. down to very low heat fluxes and low temperature differences across the wall.

Suggested use

On-site measurements of thermal resistance, R , are often applied in studies of buildings. Alternatives are to measure its inverse value, the thermal conductance which is called the Λ -value, or the thermal transmittance which includes ambient air boundary layer thermal resistance, the U -value. The measurements of R are based on simultaneous time averaged measurement of heat flux Φ and differential temperature, ΔT , (using two temperature sensors, each on a different side of the wall).

$$R = \Delta T / \Phi$$

Standards

TRSYS20 is mostly used for measurements according to standard practices of ISO 9869 and ASTM C1155 / C1046. TRSYS20 is suitable for use by ISO certified laboratories.



Figure 0.4 TRSYS20 measuring system with carrying case.

User interface: MCU as a web server

TRSYS20 is controlled via a PC. The TPSYS20 MCU can be connected to a local area network via ethernet or directly to a PC via USB. The graphical user interface is available through a webpage and can be opened in any of the supported web browsers. No installation of software is required. The graphical user interface allows the user to configure measurement parameters, control measurements, view measurement progress and to view and download measurement results.

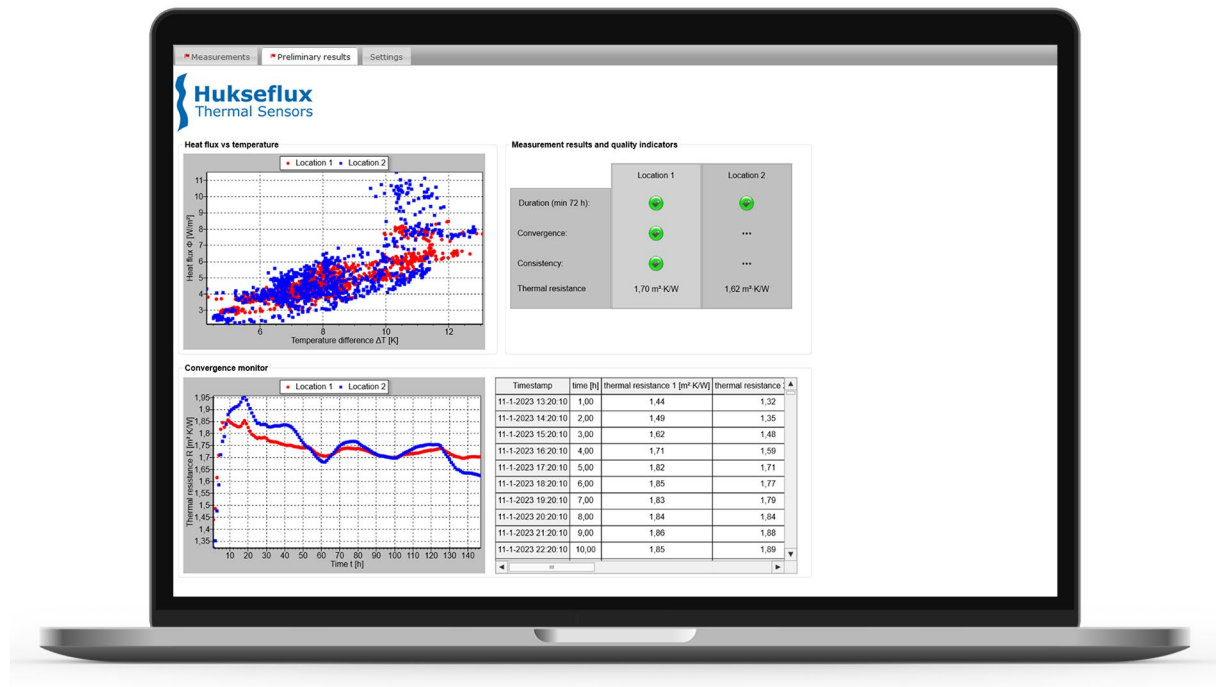

Figure 0.5 TPSYS20 graphical user interface, accessible through a web browser.

1 Ordering and checking at delivery

1.1 Ordering TRSYS20

The standard configuration of TRSYS20 is with 2 x heat flux sensor, one with 10 and one with 20 m cable, and 2 x matched thermocouple pairs, TC, one pair with 10 m cable and one pair with 20 m cable.

1.2 Included items

Arriving at the customer, the TRSYS20 delivery should include:

- 1 x carrying case
- 1 x TRSYS20, consisting of
 - a measurement and control unit (MCU)
 - 2 x HFP01 heat flux plates
 - 2 x matched thermocouple pairs
- 1 x 12 VDC Power supply unit (PSU), with 4 interchangeable AC plugs
- 1 x USB-A to USB-B cable
- 1 x product certificate TRSYS20

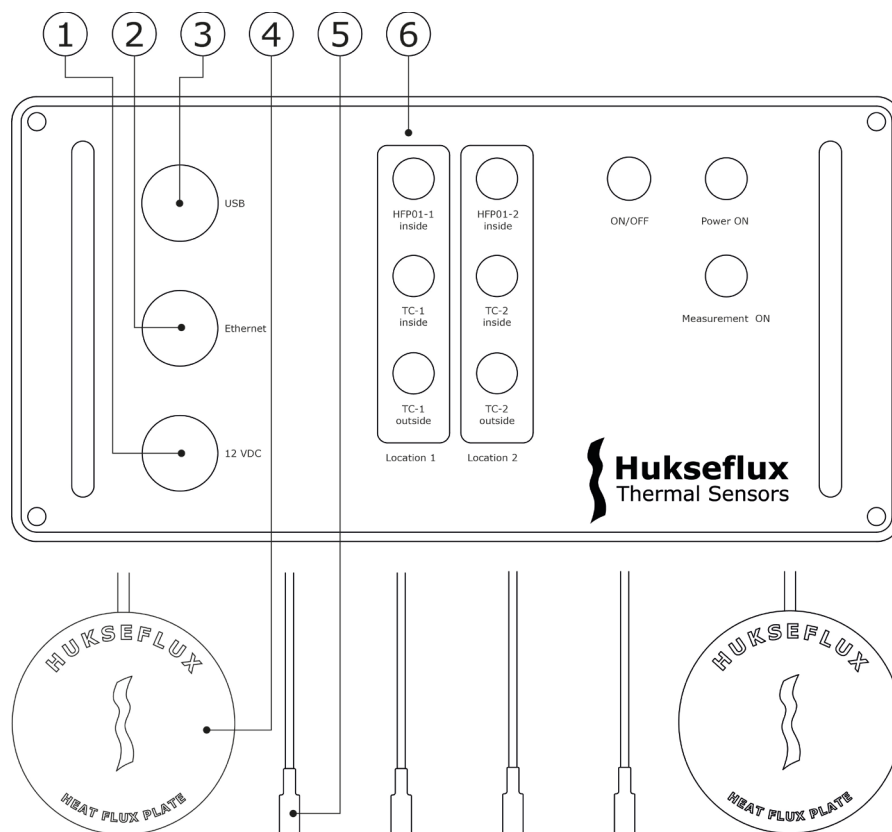

Figure 1.2.1 Overview of TRSYS20: the system includes 2x HFP01 sensor (4), 2x matched thermocouple pairs (5), and the MCU (6). The MCU is powered from a 12 VDC power source (1). Communication with the MCU can be done via an ethernet port (2) or a USB port (3).

2 Instrument principle and theory

TRSYS20 measuring system consists of multiple heat flux- and temperature sensors that are used to measure heat fluxes through- and temperature difference across walls or building envelope components. The data can be used to estimate the energy budget of buildings and to determine thermal resistance of walls. The data analysis required to determine thermal resistance, R , thermal conductance, Λ , or thermal transmittance, U , from the data is the responsibility of the user and should be performed according to ISO and ASTM recommended practices.

This chapter provides a brief introduction into the theory, the relevant standards and the TRSYS20 operating principle.



Figure 2.1 HFP01 heat flux sensor and TC mounted on a wall.

2.1 TRSYS20 measuring system

2.1.1 HFP01 heat flux sensors

TRSYS20 uses HFP01 heat flux sensors to measure the heat flux through building envelope components. Heat flux is the amount of heat flowing through a surface per unit time per unit area and is expressed in SI units of W/m^2 .

HFP01 heat flux sensor contains a thermopile that generates an output voltage that is proportional to the temperature difference across the heat flux sensor. From Fourier's law it follows that the temperature difference across the heat flux sensor is proportional to the heat flux through the sensor. Hence output voltage U is proportional to the heat flux Φ :

$$\Phi = U/S$$

Where S , a constant, is the sensitivity of the heat flux sensor. HFP01 is calibrated at the factory.

Installation of a heat flux sensor generally perturbs the heat flows. To avoid perturbing the heat flows, heat flux sensors should have a small thermal resistance while having a sufficiently large sensitivity for their application. HFP01 is designed to minimize the perturbation while having a high sensitivity.

For more details on the HFP01 heat flux sensors, the reader is referred to the [HFP01 manual](#).

2.1.2 Matched thermocouple pairs

TRSYS20 uses matched thermocouple pairs to measure temperature differences across building envelope components. While the absolute temperature measuring accuracy of individual thermocouples is low, matched thermocouple pairs can be used to very accurately measure temperature differences. Proper selection / pairing leads to uncertainties better than 0.1 °C over the full rated measurement range.

2.1.3 Measurement and control unit (MCU)

The measurement and control unit (MCU) contains a Campbell Scientific CR1000X datalogger. The MCU is used to measure the voltage signals from the heat flux sensors and thermocouples, process the signals, store measurement data and to provide a user interface.

The MCU uses high resolution AD converters to measure the voltage signals from the heat flux sensors and thermocouples. A net-frequency filter is used to minimize cross talk from power lines. The net-frequency filter must be set to net frequency (50 or 60 Hz) of the region in which the system is used. The MCU measured voltages are then converted to heat flux, temperature and temperature difference values. It has an on-board temperature sensor that acts as a cold junction measurement for the thermocouples. This is called the panel temperature.

MCU contains a clock and memory. 10 minute averages of heat flux, temperature and temperature differences are stored along with appropriate time stamps. Once a measurement has been completed, the measurement data can be downloaded from the MCU.

The MCU provides a user interface that allows the user to view live measurement data as well as preliminary results. The user interface is accessible via a PC or laptop using a web browser. To access the user interface the MCU can be connected via USB or ethernet.

2.2 Theory

TRSYS20 is a system for in-situ (or field) measurements of the thermal resistance of building envelope components as opposed to ex-situ (or laboratory) measurements.

In-situ thermal resistance evaluations use long-term averages of temperature difference across- and heat flux through the wall or building envelope component. Using the time-averaged temperature difference ΔT_{avg} and time-averaged heat flux Φ_{avg} the thermal resistance can be evaluated using the thermal equivalent of Ohm's law:

$$R = \Delta T_{avg} / \Phi_{avg} \quad \text{(Formula 2.1.1)}$$

For finite measuring times the evaluation of the thermal resistance is complicated by the fact that walls have a non-zero heat capacity. A wall absorbs and releases heat during a day. Measurement duration should be long enough to allow the R-value to stabilize. Typical measurement times are on the order of one to two weeks, with a minimum of 3 days. The required measurement time ultimately depends on the thermal properties of the wall or building envelope component as well as the measuring conditions.

There are several applicable standards for in-situ thermal resistance measurements. The standards provide guidance on how to perform measurements as well as methods for processing measurement data and obtaining thermal resistances or similar quantities of interest. Specifically, the standards contain methods for determining whether sufficient data has been collected, as well as corrections to formula 2.1.1 for finite time measurements on walls with high thermal resistance and heat capacity. These standards are discussed in more detail in section 2.2.1. The user is responsible for the data analysis.

2.2.1 Applicable standards

Table 2.2.1.1 contains a listing of applicable standards. We recommend users to purchase the latest version of the standard.

Table 2.2.1.1 *Standards with recommendations for instrument use in building physics.*

STANDARDS FOR INSTRUMENT USE FOR BUILDING ENVELOPE THERMAL RESISTANCE MEASUREMENT	
ISO STANDARD	EQUIVALENT ASTM STANDARD
ISO 9869 Thermal insulation – Building elements – In-situ measurement of thermal resistance and thermal transmittance	ASTM C 1155-95 Standard Practice for Determining Thermal Resistance of Building Envelope Components from the In Situ Data ASTM 1046-95 Standard Practice for In Situ Measurement of Heat Flux and Temperature on Building Envelope Components

2.2.2 ISO 9869-1:2014: thermal conductance (Λ -value) and transmittance (U-value)

ISO 9869-1 makes a distinction between:

- thermal resistance R from surface to surface by conduction, in SI units of $m^2 \cdot K/W$, calculated from heat flux and surface temperature difference $T_{surface}$ (or the inverse value: thermal conductance Λ , in SI units of $W/(m^2 \cdot K)$)
- thermal resistance R_T from environment to environment by convection plus conduction, calculated from heat flux and ambient air temperature difference $T_{ambient}$ (or the inverse value: thermal transmittance U)

Typically, the wall thermal conductance Λ (or thermal resistance R) is measured using surface temperatures on the wall:

$$\Lambda = 1/R = \Phi / (T_{\text{surface, indoor}} - T_{\text{surface, outdoor}}) \quad (\text{Formula 2.2.2.1})$$

The thermal resistance R of an old insulated wall is of the order of 2.5 K/(W/m²), a modern insulated wall may attain 6.7 K/(W/m²).

The thermal transmittance U is a measure how effective a material is as an insulator. The lower the U value, the less heat is lost and the more insulation the material provides. U-value includes an ambient air boundary thermal layer at the inside and outside of the wall. When measuring the thermal transmittance:

$$U = 1/R_T = \Phi / (T_{\text{ambient, indoor}} - T_{\text{ambient, outdoor}}) \quad (\text{Formula 2.2.2.2})$$

The U-value (or alternatively R_T) includes R_{ambient, indoor} and R_{ambient, outdoor}, a thermal boundary layer of air plus radiative transport resistance.

$$R_T = R + R_{\text{ambient, indoor}} + R_{\text{ambient, outdoor}} \quad (\text{Formula 2.2.2.3})$$

Formula 2.2.2.4 shows a typical assumption for non-ventilated walls for 2 surfaces:

$$R_{\text{ambient}} = R_{\text{ambient, indoor}} + R_{\text{ambient, outdoor}} = 0.25 \text{ K}/(\text{W}/\text{m}^2) \quad (\text{Formula 2.2.2.4})$$

The convective transport of heat from the wall to the ambient air, Φ , is a function of the heat transfer coefficient, h_c , and the temperature difference between ambient air and sensor.

$$\Phi = h_c \cdot (T_{\text{ambient}} - T_{\text{object}}) = (T_{\text{ambient}} - T_{\text{object}}) / R_{\text{ambient}} \quad (\text{Formula 2.2.2.5})$$

In buildings under indoor conditions we expect wind speeds of < 1 m/s. Indoor environments such as office spaces will typically have wind speeds < 0.5 m/s. Outdoors, wind speeds may reach 15 m/s under normal conditions, and up to 60 m/s in case of heavy storm.

An approximation of the heat transfer coefficient at a single surface at moderate ambient air speeds, v , and taking 5 W/(m²·K) for the radiative transfer coefficient, is given by:

$$h = h_r + h_c = 5 \text{ W}/(\text{m}^2 \cdot \text{K}) + 4 \text{ J}/(\text{m}^3 \cdot \text{K}) \cdot v \quad (\text{Formula 2.2.2.6})$$

According to ISO 9869, A.3.1, a common value for the heat transfer coefficient by convection, h_c , for a single surface is 3.0 W/(m²·K); in the equation above this would represent a wind speed of 0.75 m/s. The total heat transfer coefficient h for one surface then is 8 W/(m²·K). For two surfaces R_{ambient} then becomes 0.25 K/(W/m²) according to formula 2.2.2.4.

The radiative heat transfer coefficient of 5 W/(m²·K) follows from the Stefan–Boltzmann law, linearised around 20 °C.

In this standard the heat flux sensor name is heat flowmeter (HFM). Installation is described in ISO 9869 paragraph 6.1.2. The user should verify the representativeness of the area with a thermal camera. The installation should not be in the vicinity of potential sources of error such as thermal bridges, cracks, heating or cooling devices and fans. Sensors should not be exposed to rain, snow, and direct solar radiation. The standard recommends use of thermal paste. Hukseflux discourages the use of thermal paste

because it tends to dry out. Silicone glue and double sided tape are more reliable. The standard recommends the use of a passive guard ring. Annex D.3.2 states that "the width of the guard ring should be at least 5 times the thickness of the heat flux meter". HFP01 is equipped with a guard ring fulfilling the requirement of the standard. The ISO 9869-1 standard provides three methods for obtaining the thermal resistance from measurement data:

1. The average method (ISO 9869-1, paragraph 7.1).
2. The average method with a correction for storage effects (ISO 9869-1, paragraph 7.2).
3. The dynamic method (ISO 9869-1, Annex B).

For the average method, when measuring the thermal resistance of a building element, the duration of the test according to ISO 9869-1 should be at least 72 h (ISO 9869-1 paragraph 7.1). In some cases, only night time data may be included in the analysis. At the end of a test the obtained R – value should not deviate by more than $\pm 5\%$ from the value obtained 24 h before, i.e. the measurement should converge. Furthermore, the thermal resistance value obtained by analysing the initial 2/3 of the test data should not deviate from value obtained by analysing the final 2/3 of the test data by more than $\pm 5\%$, i.e. the measurement should be consistent. Whenever the change in heat stored by the wall is more than 5 % of the heat flow through the wall during the test period, the first method is insufficient and either the second or the third method listed above should be used.

Chapters 7 and 8 of the ISO standard describe corrections for storage effects (changes in average wall temperature), added thermal resistance by the heat flux sensor, which we call the resistance error, and errors caused by the finite dimensions of the sensor.

ISO 9869 chapter 9 shows examples of uncertainty evaluation, arriving at typical uncertainties of the order of $\pm 20\%$ of on-site measurements of thermal resistances.

Sensors for measurement of temperature difference should be calibrated to an accuracy of $\pm 0.1\text{ }^{\circ}\text{C}$, reference paragraph 9.2 of this manual.

2.2.3 ASTM C 1155 and ASTM 1046: thermal resistance R

ASTM C 1155 and ASTM 1046 focus on the measurement of thermal resistance R (from surface to surface) only. This is the R-value of formula 2.2.2.1. ASTM 1155 defines a Heat Flow Sensor or Heat Flux Transducer (HFT). Paragraph 5.8 of the standard specifies that during the test the indoor temperature changes less than $3\text{ }^{\circ}\text{C}$, and specifies that the density of the construction material is $< 440\text{ kg/m}^3$. Areas with a high lateral heat flux should be avoided. Time constants should be estimated according to ASTM 1046. The duration of the test is at least 24 h, and a convergence test may be used to determine total required timespan.

ASTM 1046 offers good practices for installation and site selection.

2.2.4 Measurements on glass windows

TRSYS20 and HFP01 may be mounted on glass windows, however special care must be taken when interpreting data from measurements on glass. When measuring glass windows please observe the following:

- During daytime, the window material typically transmits solar radiation, while the HFP01 heat flux sensors absorb this radiation. During daytime the measurement is not representative of the heat flux through the window. It is recommended to use night-time data only.
- For windows with low R-value (high Λ -value), especially single-layer glass windows, the thermal resistance of HFP01 itself may be non-negligible. The user should review their case and may correct for the resistance error.

3 Specifications of TRSYS20

3.1 Specifications of TRSYS20

TRSYS20 is a system used for on-site measurement of thermal resistance, R , thermal conductance, the Λ -value, and thermal transmittance, the U -value, of building envelope components. TRSYS20 is used for measurements according to standard practices of ISO 9869 and ASTM C1155 / C1046. The system is equipped with MCU electronics, two heat flux sensors of model HFP01 as well as two pairs of matched thermocouples. The sensors are used to measure at two locations. Data review and calculation of the thermal resistance from heat flux and temperature difference is the responsibility of the user.

Table 3.1.1 *Specifications of TRSYS20 (continued on next page).*

TRSYS20 SPECIFICATIONS	
Description	high-accuracy building thermal resistance measuring system with two measurement locations
Measurand	heat flux (2 x)
Measurand in SI units	heat flux density in W/m^2
Measurand	temperature (2 x)
Measurand in SI units	temperature in $^{\circ}C$
Measurand	temperature difference (2 x)
Measurand in SI units	temperature difference in $^{\circ}C$
Use	
Required data analysis to determine thermal resistance, R , thermal conductance, the Λ -value, and thermal transmittance, the U -value	to be performed by the user according to ISO and ASTM recommended practices
Minimum measurement duration	> 3 days
Standards governing use of the measuring system	<ul style="list-style-type: none"> • ISO 9869 Thermal insulation – Building elements – In-situ measurement of thermal resistance and thermal transmittance. • ASTM C 1155-95 Standard Practice for Determining Thermal Resistance of Building Envelope Components from the In Situ Data. • ASTM 1046-95 Standard Practice for In Situ Measurement of Heat Flux and Temperature on Building Envelope Components
Measurement locations and sensor labelling	
Number of measurement locations	2
Cable length per location	location 1: 10 m location 2: 20 m
Included sensors location 1	heat flux: 1 x HFP01-10 with 10 m cable temperature and temperature difference: 1 x TC-10 matched thermocouple pair with 10 m cable marking "TC-1 inside" and "TC-1 outside"
Included sensors location 2	heat flux: 1 x HFP01-20 with 20 m cable temperature and temperature difference: 1 x TC-20 matched thermocouple pair with 20 m cable marking "TC-2 inside" and "TC-2 outside"
Cable markers heat flux sensor	2 x sticker, 1 x at sensor and 1 x cable end, wrapped around the heat flux sensor cable. Both stickers show sensitivity and serial number.

Heat flux sensor mounting and orientation	recommended orientation is with the red face of the heat flux sensors facing indoors, and the blue face mounted at the indoor walls
Cable markers temperature sensors	location 1: TC-1 inside and TC-1 outside location 2: TC-2 inside and TC-2 outside

Table 3.1.1 *Specifications of TRSYS20 (started on previous page, continued on next page)*

Rated operating conditions	
Rated operating temperature range	HFP01 and TC: -30 to +70 °C MCU: -20 to +50 °C
IP protection class	see individual components below.
Rated operating relative humidity range	0 to 100 %
Storage and transport	
Storage	when not in use TRSYS20 should be stored inside its carrying case in a dry place. TRSYS20 MCU should be stored with the dedicated dust caps placed on connectors.
Net weight total TRSYS20 including carrying case	approx. 8 kg
Gross weight	approx. 11 kg
Carrying case	box of 480 x 390 x 190 × 10 ⁻³ m
MEASUREMENT AND CONTROL UNIT (MCU)	
Rated operating voltage	10 – 16 VDC
Recommended operating voltage	12 VDC
Power consumption	< 1 W
12 VDC connector type on MCU	Bulgin Standard Buccaneer®, PX0735/P, 2 pole connector with pins
Maximum power supply cable length	1.8 m
Sample rate	1 sample/s
Stored measurements	10 min averages of heat flux, temperature and temperature differences; instantaneous values of panel temperature, heat flux sensor 1 sensitivity, heat flux sensor 2 sensitivity
Storage capacity	> 30 days
MCU datalogger	Campbell Scientific CR1000X Measurement and Control datalogger
Ingress protection rating	IP54
Indicator LEDs	
Power switch / LED	red LED is on when power is supplied to MCU
Running LED	green LED is on when measurement is running
Internal battery for battery-backed memory and clock	
Internal system battery	AA, 2.4 A-hr, 3.6 VDC (Tadiran, TL-5903/S)
Internal battery replacement interval	3 years, can be replaced by the user
USB connector	
Connector type on MCU	USB-B socket
USB cable type	shielded
Maximum USB cable length	2.0 m
Ethernet connector	
Connector type on MCU	RJ45 (shielded)
Isolation/protection	magnetic isolation TVS surge protection
Ethernet cable type	shielded
Maximum ethernet cable length	30 m
User interface	
Hardware connection to PC	USB or ethernet (preferred for long-term use)
User interface on PC	web interface
Web browser requirement	HTML 5 support
Supported web browsers	Chrome 10

	Firefox 4 Internet Explorer 9 Opera 11 Safari 5 or later
POWER SUPPLY UNIT (PSU)	
Power supply model	Mean Well, GEM60I12 (similar power supplies may be used)
Input voltage	100 - 260 VAC
Input frequency	50 / 60 Hz
Input plug type	Type A/B (USA) Type C/F (EU) Type G (UK) Type I (AU)
Output voltage	12 VDC
Output current	4.5 A
Output cable length	approx. 1.0 m
Output connector type	Bulgin Standard Buccaneer®, PX0736/S, 2 pole connector with sockets
Ingress protection rating	IP22

Table 3.1.1 Specifications of TRSYS20 (started on previous pages).

HFP01 HEAT FLUX SENSOR	
Specifications	see HFP01 manual
Guard width to thickness ratio	5 (as required by ISO 9869 D.3.1)
Measurement function	$\Phi_1 = U_1/S_1$ $\Phi_2 = U_2/S_2$
Calibration uncertainty HFP01 heat flux sensors	$\pm 3\%$ ($k = 2$)
Ingress protection rating	IP67
TC MATCHED THERMOCOUPLE PAIR	
Thermocouple type	IEC 60584-3: 2007 type KX
Measurement function	$\Delta T_1 = T_{1, \text{indoor}} - T_{1, \text{outdoor}}$ $\Delta T_2 = T_{2, \text{indoor}} - T_{2, \text{outdoor}}$
Acceptance interval temperature difference measurement	$< \pm 0.1^\circ\text{C}$ (required by ISO 9869, paragraph 5.2)
Ingress protection rating	IP67
INSTALLATION AND USE	
Performing a representative measurement	see the chapter on standards and recommended practices for use and the chapter on installation of HFP01 and TC
Installation	see the chapter on standards and recommended practices for use and the chapter on installation of HFP01 and TC
Sensor mounting	for mounting sensors on walls, we recommend use of double-sided "removable" carpet laying tape such as TESA 4939, which has free removability up to 14 days from the most common surfaces (needs to be tested individually before usage)
CALIBRATION AND FUNCTIONAL TEST	
Performance verification	via functional test

Calibration traceability	HFP01, TC and MCU are traceable to SI units
Calibration uncertainty HFP01 heat flux sensors	$\pm 3\%$ ($k = 2$)
Acceptance interval temperature difference measurement	$< \pm 0.1^\circ\text{C}$ (required by ISO 9869, paragraph 5.2)
Recommended recalibration interval	2 yr
Electromagnetic Compatibility (EMC)	
Emission standards	EN-IEC 61326-1 (2013) EN-IEC 61326-1 (2021) EN-IEC 61000-3-2 (2014), Class A EN-IEC 61000-3-2 (2019) + AC (2021), Class A EN-IEC 61000-3-3 (2013) + A1 (2019) + A2 (2021) + AC (2022)
Emission limits	Light industrial and domestic environments, Class B
Immunity	EN-IEC 61326-1 (2013) EN-IEC 61326-1 (2021)
Immunity levels	Industrial

3.2 Dimensions of TRSYS20

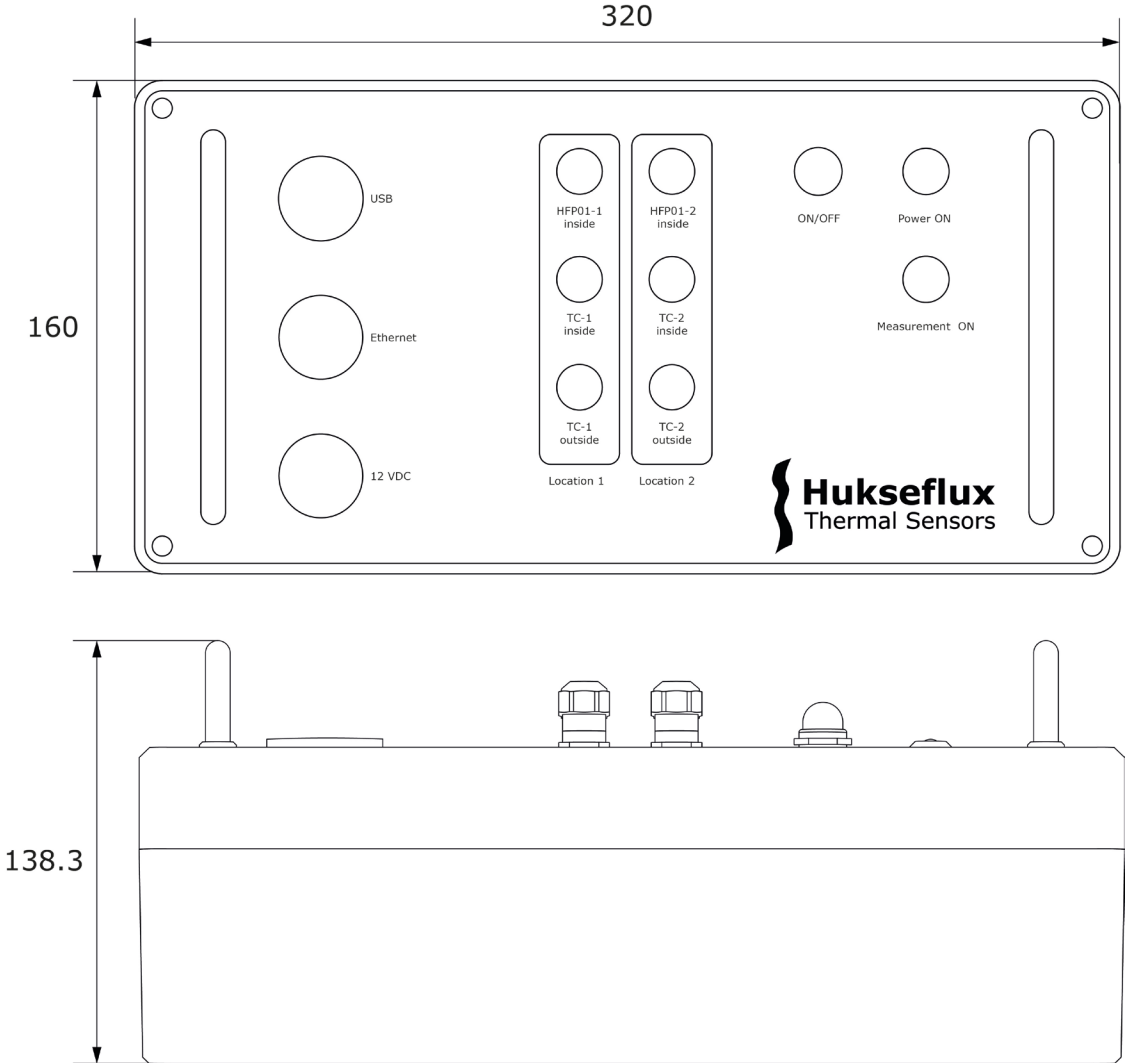

Figure 3.2.1 Dimensions of TRSYS20 MCU in $\times 10^{-3}$ m.

4 Preparation of an experiment

As a preparation, prior to performing an experiment, preferably the operator should read this manual. Furthermore, Hukseflux recommends that users familiarize themselves with the applicable ISO and ASTM standards.

4.1 Preparing the equipment

Prior to shipping TRSYS20 system to a measurement site, the user should check that the items listed in section 1.2 are present and accounted for.

Additionally, the user will need the following items not included with TRSYS20:

- Double-sided tape or glue for mounting the heat flux and temperature sensors (e.g. TESA 4939)
- Cable ties to be used as a strain relief for the sensor cables
- Sandpaper or cleaning wipes for cleaning the surface prior to mounting the heat flux and temperature sensors
- A laptop to connect with TRSYS20 MCU to start and monitor measurements

Optionally the user may want to use the following items not included with TRSYS20:

- A power extension cord to connect the PSU to mains
- A shielded ethernet cable (max. 30 m long) to connect the MCU to a LAN if desired
- A thermal imaging camera to aid in the site selection for the heat flux and temperature sensors.

5 TRSYS20 MCU system setup

This chapter describes how to setup the TRSYS20 MCU. The following steps should be completed:

1. Setting up connection with the MCU
2. Setting the MCU clock
3. Setting the net-frequency filter
4. Verifying the programmed HFP01 sensitivities

5.1 Setting up connection

TRSYS20 is operated via a laptop or PC. TRSYS20 MCU acts as a webserver such that the user interface can be accessed using a web browser. The user interface allows the user to start and monitor measurements. The TRSYS20 MCU can be connected either via USB or ethernet. If a long-term connection is desired (> 1 day) the preferred method is to use an ethernet connection, to guarantee a stable measuring performance.

5.1.1 Connection via USB

To use this option, TRSYS20 MCU should be connected directly to a free USB port on the PC or laptop using the included USB-A to USB-B cable. When using a USB connection, the Microsoft RNDIS protocol will be used to provide a 'virtual ethernet link' or 'ethernet over USB'.

Use of the ethernet over USB connection requires the Microsoft RNDIS drivers to be installed. The drivers should either be installed by default or install automatically upon connecting TRSYS20 MCU to the PC. If the drivers are not automatically installed, install the USB drivers using the Campbell Scientific Device Configuration Utility, see the appendix.

To access the graphical user interface, open a compatible web browser (see specifications chapter for a list of compatible web browsers) and enter the following URL into the address bar: <http://www.linktodevice.com>.

Alternatively, one can use the IP address to open the graphical user interface. To do so enter 'http://' followed by the IP address into the address bar. By default, the IP address is 192.168.66.1, such that <http://192.168.66.1> should be entered into the address bar

5.1.2 Connection via ethernet

To use this option, the MCU and the PC or laptop should be connected to the same LAN. The MCU will be assigned an IP address automatically.

To access the graphical user interface, open a compatible web browser (see specifications chapter for a list of compatible web browsers) and enter the following URL into the address bar: http://tpsys20_nnnnnnn, where nnnnnnn must be replaced by the 7 digit serial number of the MCU. The MCU's serial number can be found on the product certificate and on the MCU itself.

If the network does not allow for systems to assign their own name, the IP address can be used to open the graphical user interface. To do so enter 'http://' followed by the IP address into the address bar of the web browser.

The IP address of the MCU can be found using either a general purpose IP scanner, the Campbell Scientific LoggerLink Mobile Apps for iOS and Android systems, available from <https://www.campbellsci.com/loggerlink> or the Campbell Scientific Device Configuration Utility available from <https://www.campbellsci.com/devconfig>.

Once a connection to the TRSYS20 MCU has been established, it is recommended to bookmark the URL in the web browser or to create shortcut on the desktop.

NOTICE

To avoid ground loops, do not connect the ethernet port and the USB port of the TRSYS20 MCU at the same time.

NOTICE

When connecting the MCU via ethernet use a shielded ethernet cable with a maximum length of 30 metres.

5.1.3 Logging into the TRSYS20 MCU

To make sure the TRSYS20 MCU can only be controlled by the authorised users on a shared network, first time use in a new browser or PC requires the correct credentials. A pop-up will appear asking you to enter your credentials. The credentials are:

- Username:** TRSYS20
- Password:** serial number of the TRSYS20 MCU

5.2 Setting the clock

TRSYS20 system clock is used to generate datetime stamps for the measurements. Prior to using the system the clock must be set. To set the clock: in the interface select the **Settings** tab, click the **Set clock** button. This will open a new window. Click the **Sync MCU clock** button. This will synchronize the MCU time to the PC time. See figure 5.2.1.

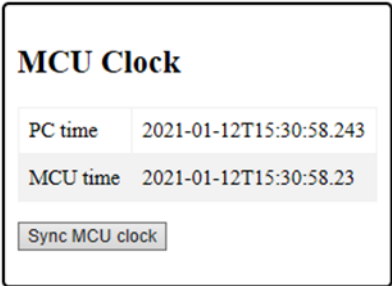

Figure 5.2.1.: Synchronizing the MCU clock with the PC clock.

5.3 Setting the net frequency filter

TRSYS20 uses a net frequency filter to reduce interference from power lines with the heat flux, differential temperature and temperature signals. The net frequency filter must be set for the region in which the system is used. To set the net frequency filter: in the interface select the **Settings** tab, in the **Net frequency** box select the **Net frequency filter** drop down list and select the net frequency for your region (e.g. 50 Hz for Europe or 60 Hz for North America). After setting the net frequency the MCU will restart. This may take a minute. The web interface may have to be refreshed.

5.4 Verifying the programmed HFP01 sensitivity

HFP01 heat flux plates are calibrated on an individual basis at the factory. To obtain correct heat flux measurements the sensitivities of TRSYS20's heat flux sensors must be programmed in the TRSYS20 MCU through the user interface. The sensitivities are preprogrammed at the factory.

NOTICE

The HFP01 heat flux sensor parameters in TRSYS20 MCU must be set such that they match the values on the calibration certificate. Failure to enter the correct sensitivities into the TRSYS20 MCU may lead to invalid measurement results.

To verify that the sensitivities have been programmed correctly select the **Settings** tab in the interface, and compare the values in the **Current sensitivity** column in the **Calibration data** box to the values found on the supplied calibration certificates or at the label at the end of the sensor cable.

In case the values are incorrect, enter the correct values found on the calibration certificate into the fields in the **New sensitivity** column in the **Calibration data** box. Once the values have been entered correctly click the **Update calibration data** button. Upon clicking the button the values in the **Current sensitivity** column will be updated.

6 Installation of sensors: HFP01 and TC

This chapter describes how to install the TRSYS20 sensors on a building envelope component (wall) that is being investigated. It is assumed that the user has completed the system setup described in chapter 5.

TRSYS20 has two sets of sensors. Each set consists of a heat flux sensor, an indoor temperature sensor and an outdoor temperature sensor.

First the user must select suitable locations for mounting the sensors. The location should be representative for the majority of the building envelope component being studied. Placement near cracks, thermal bridges, corners, heating or cooling devices should be avoided. See section 7.1 for further recommendations. A thermal imaging camera can be used as an aid in finding a suitable location.

Once a suitable location has been found the sensors must be mounted. The indoor temperature sensor and the heat flux sensor are normally mounted as close as possible on the inside of the building envelope component. The outdoor temperature sensor is mounted on the outside of the building envelope component as close as possible to the indoor sensors. It is strongly recommended to place the MCU and PSU indoors. Prior to placing the sensors, the mounting surface should be cleaned using e.g. sandpaper or cleaning tissues. Next the sensors can be mounted. Air gaps between the heat flux sensor and the building envelope component should be avoided in order to minimize thermal contact resistance. For smooth mounting surfaces double side tap may suffice, while for rough mounting surfaces a silicone glue might be more appropriate.

Movement of the sensors during the measurement should be prevented. The sensors should be mounted in a manner that will last for the duration of the experiment. It is strongly recommended to use cable ties as cable strain relieves.

Section 6.1 provides additional information on selection of suitable sensor locations, orientation of sensors and mounting of sensors.

NOTICE

Do not lengthen or shorten the sensor cables. Modification of sensor cables voids the thermocouple pairs being matched, may negatively affect electromagnetic immunity and voids the EMC declaration.

6.1 Site selection and installation

Table 6.1.1 Recommendations for installation of heat flux sensors and temperature sensors in building physics (continued on the next page).

Location	Preferably mount heat flux sensors indoors and not outdoors
	Preferably use a large wall section which is relatively homogeneous in the northern hemisphere, north-facing walls are preferred
	Do not exposure sensors to sun, rain, etc. Do not expose indoor sensors to drafts and lateral heat fluxes Do not mount sensors in the vicinity of thermal bridges, cracks, heating or cooling devices and fans

	<p>Close window blinds and curtains Switch off artificial light sources</p> <p>For detailed analysis of a single building element users may consider to install one heat flux sensor indoors, and the other outdoors. Measuring on two sides permits a detailed analysis of the thermal response time.</p> <p>For mounting sensors on glass windows: see paragraph 4.3.1.</p>
Orientation	<p>The two heat flux sensor sides are equivalent. The two temperature sensors of the matched thermocouple pair TC are equivalent.</p> <p>Recommended orientation is with the red face of the heat flux sensors facing indoors, and the blue face connected to the indoor wall. This generates a positive output signal when the heat flux direction is from indoors to outdoors.</p> <p>The thermocouples of the TC pair of location 1 are labelled TC-1-inside and TC-1-outside. In case the temperature of TC-1-inside is greater than TC-1-outside the difference has a positive sign.</p> <p>Reversing the heat flux sensor orientation or the positions of the two sensors of the TC pair will result in a change of sign of the heat flux- or temperature difference output. If necessary, this may be compensated in the post processing for example by giving the sensitivity a negative sign.</p>
Performing a representative measurement	<p>It is recommended to use 2 sets sensors on the same wall or building envelope component. This redundancy improves the assessment of the measurement accuracy.</p>
Creating a temperature difference	<p>For the measurement of thermal resistance of walls it is best to have a constant high level heat flux; strongly cooled or strongly heated rooms are ideal. We recommend activating heaters or air conditioning to create optimal conditions.</p>
Mechanical mounting	<p>Avoid any air gaps between sensors and wall. Air thermal conductivity is in the 0.02 W/(m·K) range, while a common glue has a thermal conductivity around 0.2 W/(m·K). A 0.1×10^{-3} m air gap increases the effective thermal resistance of the sensor by 60 %.</p> <p>We recommend use of double-sided "removable" floor laying tape such as TESA 4939, which has free removability up to 14 days from the most common surfaces (needs to be tested individually before usage).</p> <p>For thermocouple mounting the same tape may be used as for the heat flux sensors.</p> <p>For long-term installation and for filling up large gaps, use silicone construction sealant, glue or adhesive, that can be bought in construction depots. During curing of the silicone, typically 24 h, the sensor must be temporarily held in place by other means.</p> <p>We discourage the use of thermal paste because it tends to dry out. Silicone glue and double sided tape are more stable and reliable.</p> <p>Usually the cables are provided with an additional strain relief, for example using a cable tie mount as in figure 7.1.1.</p>
Added temperature sensors	<p>For Λ-value: temperature sensors should measure wall surface temperature. They are typically located close to the sensor attached to both sides of the wall.</p>

For R-value: temperature sensors should measure ambient air temperature. They are typically located close to the sensor at both sides of the wall, however not attached to the wall. Ambient air temperature sensors should be shielded from solar radiation.

Avoiding spectral errors

In case of exposure solar radiation or to artificial light sources, the spectral properties of the sensor surface must match those of the wall. This is attained by covering the sensor with paint or sheet material of the same colour as the wall.



Figure 6.1.1 Installation of HFP01 on a wall using two-sided "removable" floor laying tape such as TESA 4939, and a strain relief of the cable using a cable tie mount equipped with the same floor laying tape as adhesive. TC temperature sensors may be mounted in the same way.

7 Performing measurements

This chapter describes how to start measurements, monitor measurement progress and retrieve data from the MCU. It is assumed that the user has completed the system setup described in chapter 5 and has installed the sensors as outlined in chapter 6.

7.1 Starting an experiment

To start an experiment, select the **Measurements** tab in the interface. In the **Next experiment** box enter a description of the building envelope component to be measured. To start the measurement, click the **Start** button in the **Control** box. The system status should change to "RUNNING", the green indicator in the **Control** box should light up and the green measurement running LED on the TRSYS20 MCU should light up.

7.2 Monitoring measurements

A typical measurement duration is 1 to 2 weeks, with a minimum of three days. During the measurement the web interface can be used to obtain an indication of the data quality.

In the web interface select the **Preliminary results** tab. In the **Heat flux-vs-temperature** box a scatter plot of the measured heat flux versus the measured differential temperature is displayed. The graph can be used to visually inspect if sufficient correlation between heat flux and temperature is present.

In the **Convergence monitor** box a thermal resistance (R-value) versus time plot is displayed. For sufficiently long measurement duration it is expected that the computed R-value gradually converges to a fixed value. The graph may be used to visually inspect the convergence. It is important to note that the y-scale will automatically rescale. The results are also listed in table format.

The **Measurement results and quality indicators** box displays the preliminary values for the thermal resistance (R-value) of the building envelope component. The values are calculated using the average method described in the ISO 9896 standard (or see section 2.2.2 ,method 1), which is identical to the summation technique described in the ASTM C 1155 standard. It should be noted that these values are intended as preliminary values only. More sophisticated analysis as described in the relevant standards may be required and is the responsibility of the user. Raw measurement data can be downloaded in CSV format for further analysis.

Apart from the preliminary three quality indicators are displayed, that are based on requirements set in the ISO 9896 standard:

- Duration: indicates if the measurement duration exceeds the minimum requirement of 72 hours.
- Convergence: indicates if the current value of the thermal resistance deviates from the thermal resistance 24 hours ago by less than 5 %
- Consistency: indicates if the thermal resistance computed from first 2/3rds of the data differs from the thermal resistance computed from the final 2/3rs of the data by less than 5 %.

Typically, the two TRSYS20 sensor sets are placed on the same building envelope component to allow for a redundancy check. In that case the user should verify that the thermal resistances for the two measurement locations are comparable.

Apart from monitoring the measurements via the web interface it is strongly recommended to visually inspect the sensor mounting at regular intervals during the experiment. In some cases, sensors may detach from the surface of the building envelope component. Sensors detaching from the surface of the building envelope component are a source of impermissible errors.

NOTICE

It is strongly recommended to inspect sensor mounting at regular intervals during a measurement. Poor contact between sensors and building envelope component will lead to invalid results. Depending on the mounting method thermal contact may deteriorate over time.

Once the user is satisfied by the amount of data collected, the user may finish the measurement by clicking the **Stop** button in the **Control** box in the **Measurements** tab. The MCU will store the data on the CRD drive and the results will then be available for downloading and further analysis.

7.3 Retrieving measurement data

To download data from the latest measurement, click the **Download data** button in the **Data** box on the **Measurements** tab. Note that data can only be downloaded after the measurement is complete. Details about the raw data file format can be found in appendix 11.

Data from previous measurements may be accessed through the record browser. To open the record browser, click the **Browse records** button in the **Data** box on the **Measurements** tab.

8 Data analysis tool

The data analysis required to determine the thermal resistance from the measurement data is the responsibility of the user and should be performed following the practices described in the ISO and ASTM standards. To help the user get started with the data analysis, Hukseflux provides a data analysis tool in the form of an excel template. The data analysis tool uses the average method described in the ISO 9869-1 standard, which is similar to the summation technique described in the ASTM standard. It is up to the user to determine if this method is appropriate or not.

The data analysis tool can be downloaded from the TRSYS20 webinterface.

8.1 Importing the data

First the data must be downloaded from TRSYS20. TRSYS20 data files have comma separated (CSV) format. The files can be opened using Excel. Upon opening the file Excel will present the user the **Text Import Wizard**. Follow the steps in the wizard to open the file. Finally, the data must be copy-pasted into the **raw_data** tab in the excel template.

8.2 Viewing results

Once the data has been imported into the excel template, the results can be reviewed in the **results** tab.

The tab shows the resulting thermal resistances for both measurement locations, three measurement quality indicators as outlined in section 7.1 of the ISO 9869 standard, a scatter plot of heat-flux vs differential-temperature and a convergence plot for the thermal resistance estimator.

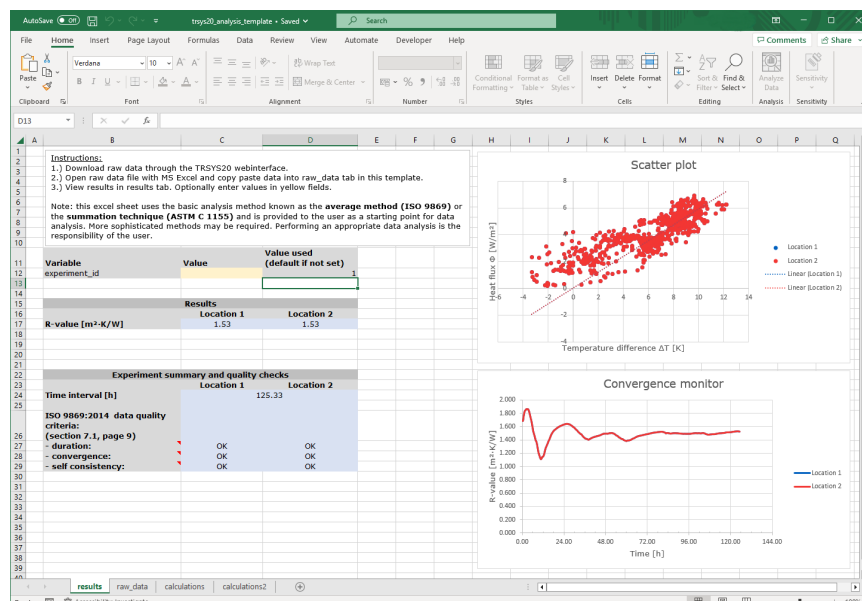

Figure 8.2.1: The results tab of the TRSYS20 data analysis tool.

9 Uncertainty evaluation

The formal evaluation of uncertainty should be performed in accordance with ISO 98-3 Guide to the Expression of Uncertainty in Measurement, GUM.

9.1 Heat flux measurements

In case of heat flux sensors, the measurement uncertainty is a function of:

- the calibration uncertainty of the heat flux sensor as well as the datalogger's analogue-to-digital converter
- differences between reference conditions during calibration and measurement conditions, for example uncertainty caused temperature dependence of the sensitivity
- the duration of sensor employment (involving the non-stability)
- application errors: the measurement conditions and environment in relation to the sensor properties, the influence of the sensor on the measurand, the influence of the tape or silicone glue used to mount the heat flux sensor, the representativeness of the measurement location

Under ideal conditions, measurements of heat flux in building physics may attain uncertainties in the $\pm 6\%$ range. Typically, however, application errors are significant. Therefore, it is not possible to give one figure for heat flux sensor measurement uncertainty. Statements about the overall measurement uncertainty should be made on an individual basis, taking all these factors into account.

For more information on the measurement uncertainty of the heat flux sensors the user is referred to the HFP01 manual.

9.2 Temperature difference

The temperature difference measurement is accurate within $0.1\text{ }^{\circ}\text{C}$ over the entire temperature range.

9.3 Thermal resistance

ISO 9869 chapter 9 shows examples of uncertainty evaluation, for thermal resistance measurement. This uncertainty budget also includes contributions from the temperature measurements and dynamic effects. It arrives at typical uncertainties of the order of $\pm 20\%$ of on-site measurements of thermal resistances.

Corrections may be applied according to chapter 8 of ISO 9869. These corrections include corrections for the thermal resistance and corrections for the finite dimension of the sensor. ISO also calls the latter the operational error, we use the term deflection error.

10 Maintenance and trouble shooting

10.1 Recommended maintenance and quality assurance

TRSYS20 measures reliably at a low level of maintenance. Unreliable measurement results are detected by scientific judgement, for example by looking for unreasonably large or small measured values. The preferred way to obtain a reliable measurement is a regular critical review of the measured data, preferably checking against other measurements, or by comparing results of the two heat flux sensors and two thermocouple pairs when mounted side by side.

Table 10.1.1 *Recommended maintenance of TRSYS20. If possible, the data analysis is done on a daily basis.*

MINIMUM RECOMMENDED HEAT FLUX SENSOR MAINTENANCE			
	INTERVAL	SUBJECT	ACTION
1	every measurement	data analysis	Compare measured data between the measurement locations. Look for any patterns and events that deviate from what is normal or expected. Compare to acceptance intervals. Plot heat flux and temperature data against the other meteorological measurands. Inspect cable quality, inspect mounting
2	12 months	inspection	Side by side comparison of the two heat flux sensors and two thermocouple pairs when mounted side by side.
3	2 years	recalibration	Recalibration of heat flux plate, matched thermocouple pairs and MCU by the sensor manufacturer
4		lifetime assessment	Judge if the instrument will be reliable for another 2 years, or if it should be replaced
5	3 years		Replace the battery in the MCU, this can be done by the user

10.2 Trouble shooting

Table 10.2.1 *Trouble shooting for TRSYS20.*

<p>The HFP01 sensor signal is incorrect, erratic or out of range</p>	<p>Check the programmed sensitivity in the TRSYS20 web interface. Make sure the programmed sensitivity matches the sensitivity on the calibration certificate.</p> <p>Check if the sensor reacts to heat: Expose the sensor heat, for instance touching it with your hand. The signal should read $> 2 \times 10^{-3}$ V now. Touching or exposing the red side should generate a positive signal, doing the same at the opposite side the sign of the output voltage reverses.</p> <p>Visually inspect the sensor cable for damage.</p> <p>Open the MCU. Locate the sensor wires. Verify that they are connected to the CR1000X datalogger. If necessary, tighten the screws on the screw terminal block on the datalogger using a Phillips head screwdriver. Check if this resolves the problem. If this does not resolve the problem, disconnect the HFP01 from the CR1000X datalogger using a Phillips head screwdriver. Check the electrical resistance of the sensor between the green [-] and white [+] wires. Use a multimeter at the 100 Ω range. Measure the sensor resistance first with one polarity, then reverse the polarity. Take the average value. The typical resistance of the wiring is 0.1 Ω/m. Typical resistance should be the nominal sensor resistance of 1 to 4 Ω plus 1.5 Ω for the total resistance of two wires (back and forth) of each 5 m. Infinite resistance indicates a broken circuit; zero or a low resistance indicates a short circuit.</p> <p>In case a HFP01 heat flux sensor is malfunctioning contact Hukseflux Thermal Sensors to discuss replacement.</p>
<p>The TC matched thermocouple pair signal is incorrect, erratic or out of range</p>	<p>Verify that the MCU panel temperature value is reasonable. Next check which of the TC matched thermocouple values are incorrect, erratic or out of range: only the indoor temperature, only the outdoor temperature or both.</p> <p>Check if the sensors react to heat: Expose the sensor heat, for instance touching it with your hand.</p> <p>Visually inspect the thermocouple cables for damage.</p> <p>Open the MCU. Locate the sensor wires. Verify that they are connected to the CR1000X datalogger. If necessary, tighten the screws on the screw terminal block on the datalogger using a Phillips head screwdriver. Check if this resolves the problem. If this does not resolve the problem, disconnect the thermocouple from the CR1000X datalogger using a Phillips head screwdriver. Check the electrical resistance of the sensors between the green [-] and white [+] wires. Use a multimeter at the 100 Ω range. Measure the sensor resistance first with one polarity, then reverse the polarity. Take the average value. The typical resistance of the wiring is 0.1 Ω/m. Typical resistance should be the nominal sensor resistance of 1 to 4 Ω plus 1.5 Ω for the total resistance of two wires (back and forth) of each 5 m. Infinite resistance indicates a broken circuit; zero or a low resistance indicates a short circuit.</p> <p>In case a temperature sensor is malfunctioning contact Hukseflux Thermal Sensors to discuss replacement.</p>

10.3 Calibration and checks in the field

The recommended calibration interval of the TRSYS20 and its individual components is 2 years. Recalibration of sensors and MCU is ideally done by the sensor manufacturer.

On-site performance verification is possibly by mounting heat flux sensors and thermocouple pairs side by side. Alternatively heat flux sensors may be stacked.

10.4 Storage

MCU and sensors should be stored in a dry place with the dedicated dust caps placed on the connectors.

11 Appendices

11.1 TRSYS20 data table

Raw data can be downloaded from the TRSYS20 MCU in .csv format. The variables in the raw data file are listed in table 11.1.1.

Table 11.1.1 *Explanation of variables and parameters used in the HF_10min data table.*

PARAMETERS USED IN HF_10min data table		
PARAMETER	DESCRIPTION	UNITS
TIMESTAMP	Date and time	YYYY-MM-DD HH:MM:SS
RECORD	Number of the record	-
experiment_id	Number of the experiment	-
panel_temperature	Temperature of the MCU panel	°C
sensitivity_hf(1)	Sensitivity heat flux plate 1	$\times 10^{-6}$ V/(W/m ²)
sensitivity_hf(2)	Sensitivity heat flux plate 2	$\times 10^{-6}$ V/(W/m ²)
heat_flux_Avg(1)	Heat flux location 1 (10 minute average)	W/m ²
heat_flux_Avg(2)	Heat flux location 2 (10 minute average)	W/m ²
temperature_inside_Avg(1)	Indoor temperature location 1 (10 minute average)	°C
temperature_inside_Avg(2)	Indoor temperature location 2 (10 minute average)	°C
temperature_difference_Avg(1)	Temperature difference location 1 (10 minute average)	K
temperature_difference_Avg(2)	Temperature difference location 2 (10 minute average)	K

11.2 EU declaration of conformity



We,

Hukseflux Thermal Sensors B.V.
Delftechpark 31
2628 XJ Delft
The Netherlands

hereby declare under our sole responsibility that:

Product model	TRSYS20
Product type	High-accuracy building thermal resistance measuring system

conforms with the following directive(s):

2011/65/EU, EU 2015/863	The Restriction of Hazardous Substances Directive
2014/30/EU	The Electromagnetic Compatibility Directive
2014/35/EU	The Low Voltage Directive

This conformity is declared using the relevant sections and requirements of the following standards:

EMC Emission	EN-IEC 61326-2-1:2013, Class B
EMC Immunity	EN-IEC 61326-2-1:2013, Industrial
Report	20230132RPT02

A handwritten signature in blue ink, appearing to be 'Eric Hoeksema', written over a light blue circular stamp or watermark.

Eric HOEKSEMA
Director
Delft, 17 April, 2023

