



# USER MANUAL **MTN02**

Multi-Purpose Thermal Needle System for  
Thermal Resistivity / Conductivity Measurement



## Warning statements



The input voltage for charging should not exceed 5 VDC as it may lead to overheating of the CRU02.



MTN02 is generally operated from its own 3.7 VDC battery. This low voltage makes MTN02 safe to use in any environment.



The TP07 needle is sharp and a potential risk to safety of the operator. When not being used, it is recommended to have a protective cover over the needle.



Putting more than 5 volt across the TP07 may result in permanent damage to the sensor.



MTN02 requires a charged battery. With an empty battery, approximately one hour of charging is required before measurements can start. 11 hours of charging are preferred.



TP07 is robust but still vulnerable. In case of doubt if it can penetrate the sample, the sample should be pre-drilled.



When calibrating in glycerol, the user is assumed to be familiar with the glycerol safety data.



Like most measurement equipment, MTN02 is not suitable for use in close proximity to high voltage cables when these are in operation.

## Contents

<b>Warning statements</b>	<b>2</b>
<b>Contents</b>	<b>3</b>
<b>List of symbols</b>	<b>4</b>
<b>Introduction</b>	<b>5</b>
<b>Ordering and checking at delivery</b>	<b>8</b>
Included items	8
<b>1 Theory</b>	<b>9</b>
1.1 General Non-Steady-State Probe Theory	9
1.2 Data analysis in the CRU02	10
1.3 Data review on PC	11
<b>2 MTN02 design considerations</b>	<b>12</b>
<b>3 General Directions for Performing a Measurement</b>	<b>14</b>
<b>4 MTN02 Specifications</b>	<b>15</b>
4.1 Specifications of MTN02	15
<b>5 Arrival of a New MTN02</b>	<b>17</b>
5.1 Preparation before Arrival	17
5.2 Checking upon Arrival	17
<b>6 Quick System Test</b>	<b>18</b>
<b>7 User Guide</b>	<b>20</b>
7.1 Preperation	20
7.2 Cautionary Notes	20
7.3 Performing Measurements	20
7.4 Calibration	21
7.5 Menu Structure	22
7.6 Software	23
<b>8 Data Transfer, Archiving and Review</b>	<b>24</b>
8.1 Connecting CRU02 and PC, downloading data to a PC	24
8.2 Reviewing Data in the Hukseflux CRU02 manager	25
8.3 Reviewing Data in Excel	29
<b>9 Maintenance and Storage</b>	<b>31</b>
<b>10 Delivery and Spare Parts</b>	<b>32</b>
<b>11 Appendices</b>	<b>33</b>
11.1 Appendix on modelling TP07 behaviour	33
11.2 Appendix on ASTM and IEEE standards	34
11.3 Appendix on insertion of the needle into hard soils	35
11.4 Appendix on typical soil thermal properties	36
11.5 Appendix on glycerol / glycerine	36
11.6 Appendix on electrical connection of TP-CRU02	37
11.7 Appendix on trouble shooting	38
11.8 Appendix on replacement of a TP	38
11.9 Appendix on battery charging	39
11.10 Appendix on downloading new software versions	39
11.11 Appendix on literature references	39
11.12 Glycerol Material Safety Data Sheet (93 / 112 EC)	40
11.13 International Chemical Safety Card for Glycerol	43
11.14 EC Declaration of Conformity	46

## List of symbols

### Quantities

Thermal diffusivity  
 Distance from the heating wire  
 Heating cycle time  
 Thermal conductivity  
 Time  
 Temperature  
 Differential temperature, or temperature rise  
 Electrical resistance  
 Electrical resistance per meter  
 Thermal resistivity  
 Diameter  
 Volumetric heat capacity  
 Density  
 Current  
 Power  
 Power per meter

Symbol	Unit
$a$	$m^2/s$
$r$	$m$
$H$	$s$
$\lambda$	$W/(m \cdot K)$
$t$	$s$
$T$	$K$
$\Delta T$	$K$
$R_e$	$\Omega$
$R_{em}$	$\Omega/m$
$R_{th}$	$m \cdot K/W$
$D$	$m$
$C_v$	$J/(K \cdot m^3)$
$\rho$	$kg/m^3$
$I$	$A$
$P$	$W$
$Q$	$W/m$

### Subscripts

Property of Pt 1000 sensor  
 Property of the heating wire  
 Property of the needle  
 Property, at  $t = 0$ , at  $t = 180$ ,  $t = h$  seconds

sen  
 heat  
 needle  
 0, 180, h

## Introduction

The MTN02 Multi-purpose Thermal Needle System allows performing fast measurements of the thermal resistivity or conductivity of soils. The system can be used in the laboratory as well as on site. The sensor is a Non-Steady-State Probe (NSSP), TP07, which is mounted on the Insertion Tool (IT03). The system is operated using a hand-held Control and Readout Unit (CRU02).



**Figure 0.1** Key components of MTN02 system: from left to right thermal properties sensor TP07 on Insertion Tool IT03 and Control and Readout Unit CRU02.

Hukseflux is specialised in NSSP design. Alternative models, for instance for laboratory use, are available at Hukseflux.

The measurement method is based on the so-called Non-Steady-State Probe (NSSP) technique, which uses a probe (also called thermal properties sensor or thermal needle) in which both a heating wire and a temperature sensor are incorporated. The probe is inserted into the soil. From the response to a heating step the thermal resistivity (or the inverse value, the conductivity) of the soil can be calculated. The measurement with MTN02 complies with the IEEE Guide for Soil Thermal Resistivity Measurements (IEEE Standard 442-1981(03)) as well as with ASTM D5334-14 Standard Test Method for Determination of Thermal Conductivity of Soil and Soft Rock. The main applications of MTN02 are the analysis of soil samples in the laboratory and field experiments in relatively soft soils.

In general a NSSP consists of a heating wire, representing a perfect line source, and a temperature sensor capable of measuring the temperature at this source. The probe is inserted into the soil that is investigated. The NSSP principle relies on a unique property of a line source: after a short transient period the temperature rise,  $\Delta T$ , only depends on heater power,  $Q$ , and medium thermal conductivity,  $\lambda$ :

$$\Delta T = (Q / 4 \pi \lambda) (\ln t + B)$$

With  $\Delta T$  in K,  $Q$  in W/m,  $\lambda$  in W/(m·K),  $t$  the time in s and  $B$  a constant. By measuring the heater power, and tracing the temperature in time (for MTN02 typically during 5 minutes),  $\lambda$  can be calculated.

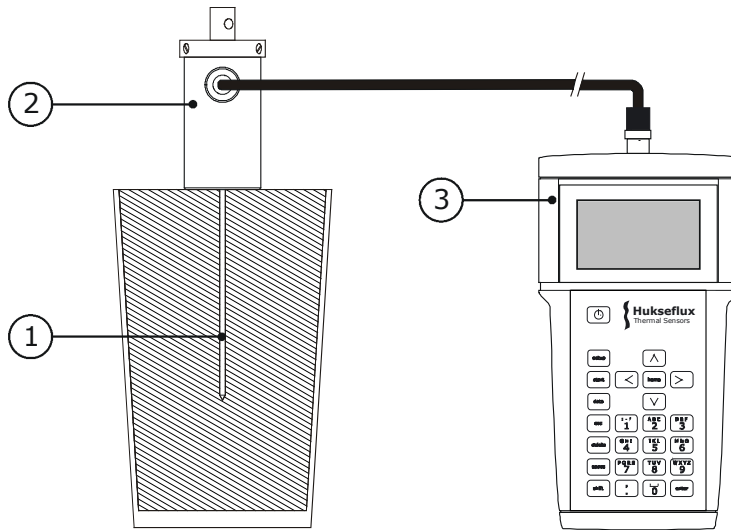

**Figure 0.2** MTN02 in operation. The Non-Steady-State Probe TP07 (1), mounted on the Insertion Tool IT03 (2), is inserted into the soil sample. The user performs control and readout of the experiment from the CRU02 (3), using its keyboard and LCD. The CRU02 also contains a rechargeable battery for powering the TP07. The measurement result is immediately generated.

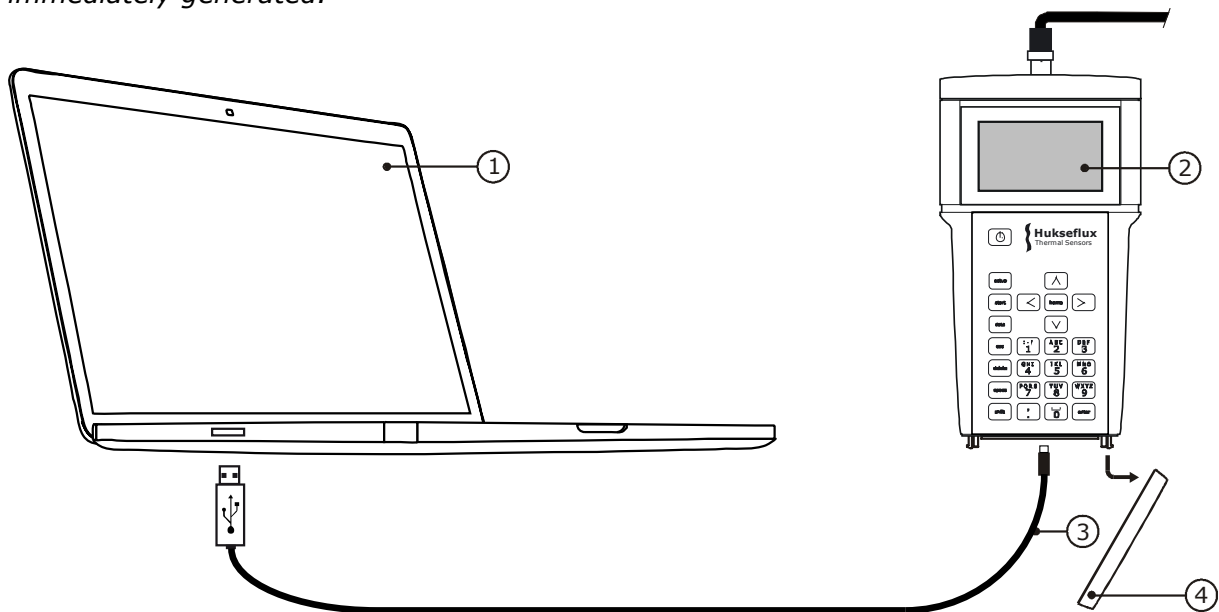

**Figure 0.3** For additional quality insurance, the data of the measurements can be stored and downloaded to the PC, and reviewed using the CRU02 software (1). The CRU02 (2) can be connected to the PC by removing a cover (4) and connecting the USB cable on both sides (3). Visual data review is required by ASTM.

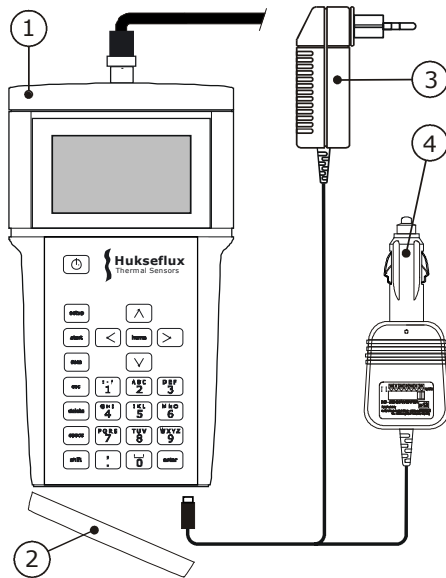

**Figure 0.4** *The CRU02 (1) can be recharged: Remove the cap (2), plug in the wall socket adapter WSA02 (3) or the car adapter CA02 (4).*

Chapter 1 contains information about theory of the NSSP and data analysis, chapter 2 summarises the design criteria and chapter 3 gives general directions for performing a measurement. After chapter 4, the instrument specifications, the remaining chapters contain information about testing the instrument on arrival, operation in the field, operation of the software, calibration and maintenance.

## Ordering and checking at delivery

### Included items

MTN02 delivery includes the following items:

- Manual MTN02
- CRU02 Control and Readout Unit
- IT03 Insertion Tool
- TP07 Thermal Properties Sensor
- PT02 Protection tube
- TC02 Transport Casing
- JR01 Jar for glycerol, with polyester fibres
- Calibration certificate for TP07
- Factory Test Certificate for CRU02
- CRU02 Manager Software on Hukseflux USB flash drive
- TP07 Thermal Properties Sensor (1 piece as spare)
- CA02 Car Adapter for 12 to 24 VDC
- WSA02 Wall Socket Adapter for 220 or 110 VAC
- USB Cable for CRU02 to PC connection

Delivery does NOT include glycerol fluid. This has to be locally obtained by the customer.

MTN02 software can be updated by the customer. New software versions are available on a regular basis. For available software / firmware updates, please check:

<http://www.hukseflux.com/page/downloads>



# 1 Theory

## 1.1 General Non-Steady-State Probe Theory

For determining the thermal conductivity of materials various types of measurement equipment can be used. In general one can make a distinction between steady-state techniques in which the investigated sample is supposed to reach a perfect thermal equilibrium, and non-steady-state techniques. In non-steady-state techniques the material properties are determined while the sample temperature still changes.

The main advantage of steady-state techniques is the simplicity of the analysis of stabilised constant sensor signals. The main advantages of non-steady-state techniques are the short measurement time and the fact that the sample dimensions do not necessarily enter the equation.

The only Non-Steady-State technique that has been standardised is the one using a single needle probe (Non-Steady-State Probe or NSSP) like TP09.

ASTM D5334-14 and IEEE Std 442-1981(03) "Standard Test Methods" specify the use of the NSSP in soil and soft rock. More information about these standards can be found in the appendices.

In general a NSSP consists of a heating wire, representing a perfect line source and a temperature sensor capable of measuring the temperature at this source. The probe is inserted into the soil that is investigated. The NSSP principle relies on a unique property of a line source: after a short transient period the temperature rise,  $\Delta T$ , only depends on heater power,  $Q$ , and medium thermal conductivity,  $\lambda$ :

$$\Delta T = (Q / 4 \pi \lambda) (\ln t + B) \quad \text{Formula 1.1.1}$$

With  $\Delta T$  in K,  $Q$  in W/m,  $\lambda$  in W/(m·K),  $t$  the time in s and  $B$  a constant.

The thermal conductivity can be calculated from two measurements at  $t_1$  and  $t_2$ . For TP07 (3.5 mm diameter) both  $t_1$  and  $t_2$  are higher than 100 s, and typically 150 s apart.  $\Delta T$  is the temperature difference between the measurements at time  $t_1$  and  $t_2$ , taking  $t = 0$  at the moment that the heating starts.

$$\lambda = (Q / 4 \pi \Delta T) \ln(t_2 / t_1) \quad \text{Formula 1.1.2}$$

The sample size is not critical, as long as a radius around needle is covered that is roughly 50 times the needle radius, in case of TP07 (the needle of MTN02), which has a 1.75 mm radius: 90 mm. (please note that with low conductivity media like dry sand, glycerol and Perspex, the sample diameter can be reduced to 55 mm)

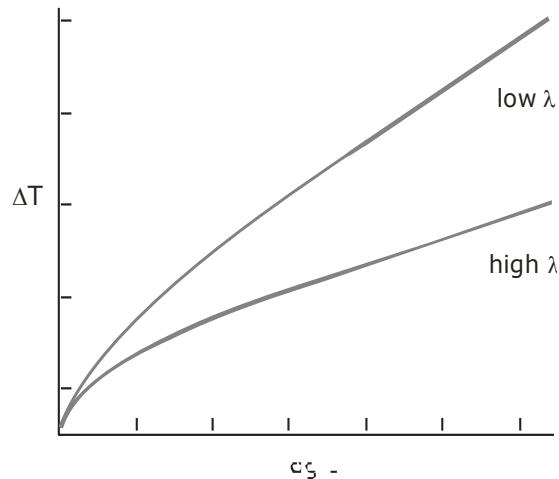

**Figure 1.1.1** The signal of MTN02 as a function of the natural logarithm of time. After a transient period the graphs show linear behaviour. In this phase the slope of the graph is inversely proportional to the thermal conductivity  $\lambda$ .

The formula 1.1.2 is a first order approximation that is only valid under certain conditions.

The most important ones are that the medium has reasonable thermal contact with the probe, that the probe is not moving and that the soil is thermally stable. More details can be found in the specifications and the directions for performing a measurement. More details on the mathematics and literature references can be found in the appendix. Whether TP07 has passed the transient period is usually apparent from the standard deviation of the measurement result on the CRU02 screen. Alternatively it can later be checked by review of the data that are extracted from the CRU02.

The measurements of  $Q$ ,  $t$  and  $\Delta T$  are all direct measurements of power, time, and temperature and are done without need of reference materials. The measurement with MTN02 is absolute.

Apart from the term "thermal conductivity", also the term "thermal resistivity"  $R_{th}$  is often used.

$$R_{th} = 1 / \lambda \quad \text{Formula 1.1.3}$$

In this manual only the term thermal conductivity is used.

## 1.2 Data analysis in the CRU02

Because of the variable conditions in field measurements, data analysis of the measurement results is hard to automate. In the CRU02 a first result is calculated by analysis of the last half of the measurement cycle. Taking a heating time of  $H$  seconds (typically 300 seconds), the last half is typically 150 seconds. Of this last half, the slope is calculated over several intervals;  $0.5H$ ,  $0.4H$ ,  $0.3H$  and  $0.2H$ . Both the average and the standard deviation, expressed as a percentage of the average, are calculated.

### 1.3 Data review on PC

The data review on PC can serve to increase the reliability of the measurement. The general idea is that with automatic analysis, there still is the risk of wrong data being accepted.

The figures below give an example of data analysis within Excel, using the measured data that are downloaded from the CRU02 to the PC.

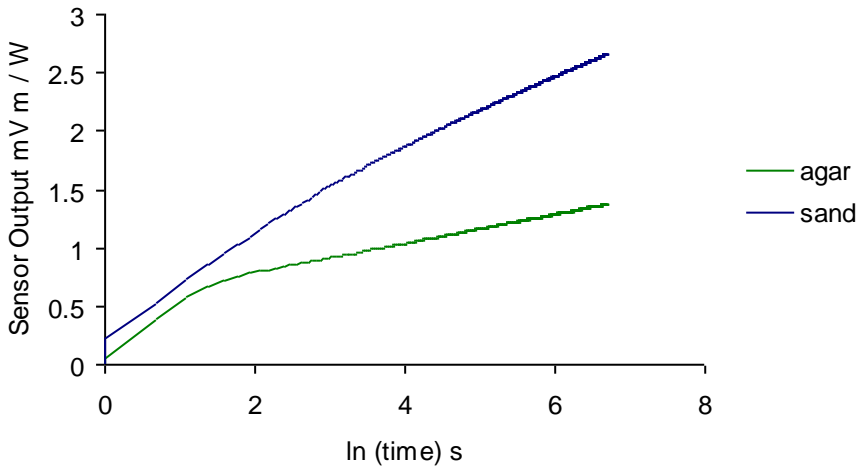

**Figure 1.3.1** Typical measurement results in agar gel and dry sand. The thermal conductivity's are 0.6 and 0.3 respectively. The linear portions of the graph have to be selected by the user. The graph illustrates that the portion that is suitable for analysis changes from one medium to the other.

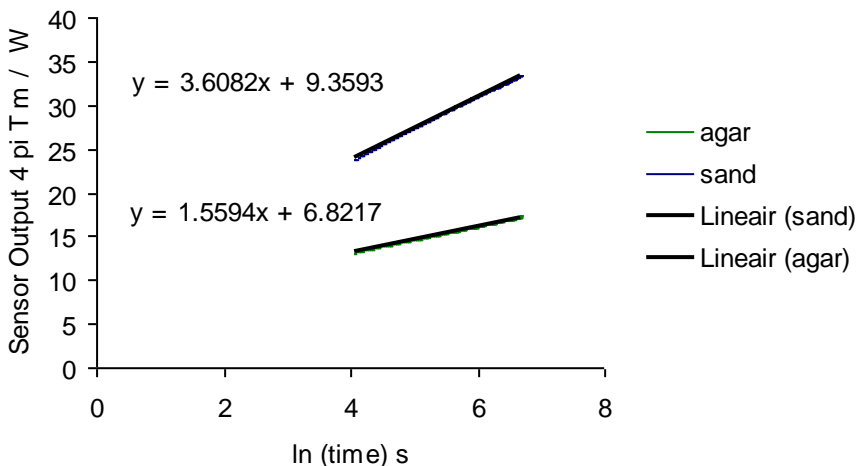

**Figure 1.3.2** Example of data analysis in Excel. See also formula 1.1.1. A linear portion of the graph of the figure 1.3.1 has been selected. The temperature  $T$  has been multiplied by  $4 \pi$  and divided by the heating power per meter. The Excel program can automatically calculate the best linear fit. The end result for the thermal conductivity's is  $1/3.608$  and  $1/1.559$ , which is 0.27 and 0.64 W/(m·K) respectively.

## 2 MTN02 design considerations

MTN02 has been designed:

1. to be suitable for laboratory measurements
2. to be suitable for field surveys for electric cable trajectories and trajectories of heated oil pipelines
3. to be compliant with existing standards
4. to produce relatively simple measurement results, allowing on site automatic measurement as well as subsequent review on PC using stored data.
5. to have a traceable calibration that can be repeated on site
6. to be locally serviceable
7. to allow entering software updates by the user
8. to be compatible with FTN02

### 1. *Suitability for laboratory measurements:*

MTN02's primary focus has been on the capability to perform laboratory measurements. The needle of TP07 is relatively thin, so that common samples can be used. The IT03 can be mounted on the levers that are commonly used in machine shops so that the needle can be vertically inserted into the sample.

### 2. *Suitability for field measurements:*

MTN02's can, provided that soils are relatively soft, also be used for field measurements. In case of harder soils, the use of stronger needles (like TP09) is recommended. MTN02 is able to perform measurements without external power source. The system is sufficiently robust to survive manual insertion into most common soils. The system runs as a stand-alone unit, powered by the batteries in the CRU. Recharging can be done by a 12VDC source or a car battery using the CA02 car adapter, or on 220/110 VAC using the WSA02 wall socket adapter.

### 3. *Complying with standards:*

For institutes that prefer to work according to standardised procedures: The measurement with MTN01 is compliant with the ASTM standards D5334-14 and IEEE Std 442-1981(03).

### 4. *Automatic processing and visual review:*

CRU02 automatically processes the measurement data, and gives both an end-result and a quality indication of the measurement. The MTN02 has a fairly simple signal analysis, only involving the conversion of the signal to a logarithmic scale, and establishing the slope of the curve. CRU02 can archive 50 measurements. In case of review, the end result is preferably checked and recalculated by analysis of the measured data in a spreadsheet (like Excel) or a mathematical program.

Note: Hukseflux as well as ASTM recommend performing a visual data review, using the stored data. *To allow entering software updates by the user.*

New software versions can be sent over internet and loaded into the CRU02 by the user.

### 5. *Local calibration:*

The MTN02 measurement is absolute and traceable to the measurement of the heater resistance and the Pt1000 properties. For all practical calibration purposes however, it is recommended to use glycerol at 20 degrees C which is easily obtainable and has a well established thermal conductivity. Verification of the stability of the total system can be done by repeated (half-yearly) testing in glycerol. This test can also be performed in the field.

6. *Local servicing:*  
MTN02 can be serviced locally; in case of broken or bent probes, these can easily be replaced.
7. *Software upgrades:*  
New software versions can be sent over internet and loaded into the CRU by the user.
8. *Compatibility with FTN:*  
For measurements specifically at 1.5 meters depth, FTN02 is available.

## 3 General Directions for Performing a Measurement

The measurement must be performed conforming to the following procedures:

- 1. Make sure that the probe has good thermal contact to the soil.*  
In case of large air gaps between probe and soil, the soil should be compressed again by hand to the original density. In case this is not possible filling material (loose sand, silicone based thermal paste, toothpaste) can be used.
- 2. Verify that the probe is not moving before and during the measurement.*  
The measurement technique introduces a heat flow into the material. It is assumed that this heat is transported by conduction and that there are no temperature changes caused by other sources. The probe is supposed to be static before and during the actual experiment.
- 3. Set up the correct power level.*  
The heating voltage of MTN02 can be adapted. In badly conducting soils, like dry soil, there is less need for heating than in well conducting soils. If possible, do not heat more than necessary.
- 4. Wait for thermal equilibrium.*  
After inserting the probe into the soil, wait for at least 5 minutes before starting a measurement. For example: when bringing a probe from a hot environment into a relatively cold soil, the probe will need some time to adapt. The CRU02 automatically waits for sufficient equilibrium. This can be overruled, but it is recommended not to do this.
- 5. Work at the highest possible level of reliability.*  
Replace bent probes as soon as practically possible.
- 6. Work at the highest level of quality assurance.*  
Whenever possible perform calibrations in glycerol as a check of good instrument performance. This measurement can also be performed in the field.
- 7. Work at the highest level of quality assurance.*  
Optimal results are obtained when measurement results are critically reviewed before final acceptance. First of all this should be done against common experience. (see appendix about expected values). Also visual data review is recommended if possible.
- 8. The procedures as recommended in the ASTM and IEEE standards offer a good guideline, but do not need be followed under all conditions.*

## 4 MTN02 Specifications

### 4.1 Specifications of MTN02

MTN02 Multi-purpose Thermal Needle System for Thermal Conductivity / Resistivity Measurements is used for determining the thermal conductivity or resistivity of the soil in which it is inserted. It consists of an IT03 (Insertion tool), which serves to support the TP07 (Non-Steady-State Probe), CRU02 (Control and Readout Unit). MTN02 is supplied with CRU02 Manager Software for the collection, archiving and review of data.

**Table 4.1.1** *Specifications of MTN02 (continued on next pages)*

<b>GENERAL SPECIFICATIONS</b>	
Measurement method	Absolute measurement, according to the standards ASTM D5334-14 and IEEE Std 442-1981(03).
Specified measurements	Thermal conductivity of soils as specified under suitable soils. Directions from the manual should be followed.
Suitable soils	Granular soils (grain size smaller than 3 mm), soils, slurries, mud and soft rock in the thermal conductivity ( $\lambda$ ) range of 0.1 to 6 W/(m·K). Essentially this includes all known soil types.
Soil requirements	Preferably the soil is in good contact with the TP07 needle. Hard soil or soft rock may be pre-drilled. Filling material may be used to promote contact. The soil must be thermally stable ( $dT/dt < 1\%$ of the heater induced change typically, 5 % max) and reasonably homogeneous. In case of soil samples: please consult Hukseflux about alternative needles.
Duration of the heating cycle H	H must be as short as medium and readout allow. 300 seconds (typical). Empirically verified for each soil type.
Heating Power / meter Q	Q must be as low as the medium and readout allow. Typically Q is adjustable so that the temperature rise is no more than 3 degrees. Typically lower than 5 W/m.
Temperature range	-30 to +80 °C (TP07) 0 to +80 °C (CRU02 and Cable)
Protection class	IP68 (TP07 and IT03) IP64 (CRU02)
ISO requirements	MTN02 is suitable for use by ISO certified laboratories
Shipment	Total weight including all accessories & packing: approx. 7 kg (net approx. 6 kg) Dimensions: transport case TC02 is 460x360x150
CE requirements	MTN02 complies with CE directives
<b>MEASUREMENT SPECIFICATIONS</b>	
Data analysis	First automatic analysis: by CRU02 Second review: Using CRU02 software on the PC the stored data can be transmitted from the CRU02 to the PC and be exported to a spreadsheet (Excel) or a dedicated mathematical program.
Expected accuracy	Thermal conductivity: $\pm (6\% + 0.04 \text{ W}/(\text{m}\cdot\text{K}))$ for homogeneous soils with good contact to the probe. Temperature reading: $\pm 4 \text{ }^\circ\text{C}$
Repeatability	Thermal Conductivity: $\pm 2\%$
Temp. Dependence	$< \pm 0.04\% / ^\circ\text{C}$ after correction of Pt1000 temperature dependence

<b>TP07 NON STEADY STATE PROBE SPECIFICATIONS</b>	
Heater R <sub>e</sub>	85 Ohm/m (nominal), specified for each individual sensor within ± 1 %
Temperature	Pt 1000 Class B, IEC 751:1983
Probe dimensions	Needle: 3.5 mm diameter, length 120 mm
<b>CRU02 CONTROL AND READOUT UNIT SPECIFICATIONS</b>	
Measurement specifications	Display of thermal conductivity and standard deviation of the thermal conductivity Variable heating level Variable heating time
Data Storage	50 measurements can be stored. Including text comment.
Power supply	Battery Powered, rechargeable Lithium-Ion battery pack. When empty: full charging from a 5 VDC, 1A source takes 11 hours. Measurements after 1 hour.
Software	New firmware versions can be downloaded through the USB port
Connection	2 m cable to IT03, ending in a Binder connector.
Data transfer	USB
<b>CA02 CAR ADAPTER SPECIFICATIONS</b>	
Connection	12 VDC or 24 VDC power supply through a car lighter connector
Output	5 VDC 1 A
Connector	DIN ISO 4165
<b>IT03 INSERTION TOOL SPECIFICATIONS</b>	
Connector type	Serie 713/763 M12 Binder connector
<b>WSA02 WALL SOCKET ADAPTER SPECIFICATIONS</b>	
Power supply	100-240 VAC 50/60 Hz
Output	5 VDC 1 A
Plug	Suitable for most international wall sockets (set of different plugs is included)
<b>CRU02 SOFTWARE SPECIFICATIONS</b>	
Required PC	Windows XP or higher, one free USB port, 30 MB hard disk space
<b>CALIBRATION</b>	
Calibration traceability	Pt1000 according to IEC 751:1983
Recalibration interval	Every 6 months using glycerol reference fluid or CRC cylinders
Recalibration interval CRU02	Every 2 years by sending CRU02 to the factory for recalibration (recommended)



## 5 Arrival of a New MTN02

### 5.1 Preparation before Arrival

As a preparation, preferably the operator should read the chapters 1 to 4.

**Table 5.1.1** *List of items that the operator should have available*

<b>ITEM</b>	<b>REMARKS</b>
Glycerol Fluid	Consumer quality of at least 96 % purity, 1 litre
PC (optional)	Running MS windows XP or higher, with one free USB port
Power	5 VDC power supply or car battery or 110-240 VAC

### 5.2 Checking upon Arrival

When the instrument arrives, it is recommended to check if the delivery is complete. The list of delivered items can be found in the chapter on Ordering and Checking at Delivery and in the appendix. The most common overall system check is to perform a first measurement in glycerol. For this see the next chapter.

## 6 Quick System Test

The CRU02 can be operated using the following buttons:

**Table 6.1** *Essential buttons on CRU02*

<b>BUTTON</b>	<b>FUNCTION</b>
ON/OFF button	Switching ON and OFF
ENTER	For selecting menu's or functions
ARROW $\wedge$	SCROLLING UP in a menu INCREASING values
ARROW $\vee$	SCROLLING DOWN in a menu DECREASING values
ESC	ESCAPING, cancelling or going back

The MTN02 is shipped ready for use. In case the battery is empty one should recharge. For recharging see the appendix (11.9) on recharging.

**Table 6.2** *Delivery of CRU02. Essentially it is shipped ready for use.*

<b>ITEM</b>	<b>ACTION</b>
Batteries	Charged
Heating duration	Set up to 300 s
Heater Voltage	Set up to 3 V
Heater Resistance	In accordance with the TP that is mounted on the IT03

The following table contains the procedure for a quick system test. By performing this test, one will see how the system works. After this system test, it is suggested to read the following chapters on the user guide and the data transfer and review.

**Table 6.3** *Procedures for a quick system test*

	<b>PROCEDURE</b>
1	Fill the jar JR01 with glycerol. There now should be a mix of fibres and glycerol.
2	Put the TP07 into the glycerol
3	Connect CRU02 to the IT03
4	Press ON/OFF to start the CRU02. The end result should be a screen with title " - CRU02- "
5	Press ARROW V to menu "Start Measurement"
6	Press ENTER The system now analyses if the situation is sufficiently stable to perform a measurement. There is a countdown for 60 seconds, and the temperature gradient is shown on the display. After 60 seconds, the system either accepts, or waits for the proper conditions. After acceptance, the measurement is started. During the next 300 s, the temperature and current reading is visible on-screen.
7	After the measurement, possible measurement warnings can be shown. If so, press ENTER
8	Now 4 different calculated values of the thermal conductivity appear, all determined using a different part of the measured curve. The value "standard dev" is the standard deviation as a percentage of the average value. This value is a quality indicator, and should be less than 0.1 The value " averaged" is the average, which is the measurement end result in W/(m·K)
9	The value in glycerol should be between 0.25 and 0.35 W/(m·K). The value of CRC05 should be between 0.16 and 0.25 W/(m·K). The standard deviation should be less than 0.1 W/(m·K)
10	Press ENTER to continue A graph of the performed measurement is shown
11	Press ENTER To add measurement information, press ENTER
12	Press ARROW Λ or ARROW V to scroll between fields, press ENTER to select a measurement information field. Text can be typed with the numerical pad. Press ENTER to submit the measurement information. When done with adding information, press ARROW < to go back
13	Press ARROW V to store data
14	The CRU shows in which slot the data will be stored. Press ENTER to store the data, press ESC to discard the data
15	The system is ready for the next measurement

## 7 User Guide

### 7.1 Preparation

The user should be familiar with the previous chapters. The user should have performed the quick system test. The user now knows how the system works.

The CRU02 batteries should be charged; this is simply done by putting CRU02 to the charger for 11 hours before the measurement campaign. If this amount of time is not available, after about one hour of charging the first measurements can be done.

It is recommended to verify that the probe resistance as entered into the CRU02 is correct. Menu "Setup measurement" → "Heater Ohm/m".

It is recommended to verify date and time: "Setup measurement" → "Date and time".

Before a measurement campaign, it is recommended to clear the memory: "Data access" → "Clear all data".

If possible, a jar with glycerol for field calibrations should be prepared.

Before and after any campaign the system should be checked according to the procedure in the quick system test.

### 7.2 Cautionary Notes

The user should be familiar with the safety issues that are indicated on the initial pages of this manual.

### 7.3 Performing Measurements

The general rules for performing a correct measurement are already laid down in an earlier chapter.

For MTN02 one might add the following:

1 In case the measurement appears to have a standard deviation larger than 0.1 repeatedly, probably the heating level is too low. The problem can be solved by going to menu "Setup measurement" → "Heating voltage". Increase the heating voltage with the ARROW  $\wedge$ .

2 In case there is need for battery saving, the backlight can be turned off. Go to "Setup Measurement" → "Backlight".

3 After a measurement has been carried out, additional information can be entered with each measurement. This can only be done direct after the measurement.

4 The decision about the exact tools to be taken on a measurement campaign is left to the user; however, one should take a ground drill and in case of hard soils and some filling material.

5. Power level of 3 V and heating time of 300 seconds are settings that works for the most of the soils.

## 7.4 Calibration

Preferably calibrations are performed before and after the measurement campaign, using glycerol gel or using CRC Calibration Reference Cylinders. If possible, these calibrations can also be performed in the field for extra quality assurance.

The advised setting for a calibration is 300 s, 4 V.

One can perform a calibration by measuring specimen with known thermal properties. This can be CRC04 or glycerol with fibres. Knowing the thermal properties of the specimen, the deviation from perfect behaviour can be calculated.

If glycerol is used, make sure the glycerol gel and the polyester fibres are very well mixed ensuring homogeneity of the fibres.

If CRC04 is used, perfect contact between TP07 and CRC04 is ensured by putting glycerol in CRC04.

When deviating within (12 % + 0.08 W/(m·K)), twice the accuracy, it is suggested not to change the calibration information. If the deviation of the measurement is outside the range mentioned above, it is recommended to adapt the calibration of the heater resistance accordingly.

If the calculated thermal conductivity is lower than expected by a certain percentage, the apparent output is too high relative to the apparent heating power. This can be corrected by assuming that a higher power has been applied, which is achieved by increasing the heater resistance in Ohm/m by the same percentage.

For information on factory recalibration of CRU02, see the chapter on maintenance and storage.

## 7.5 Menu Structure

**Table 7.5.1** Menu structure of the software running on the CRU02. The menu is largely self-explanatory. Text can be entered using the numerical keyboard. Comments are in italics.

LEVEL 1	LEVEL 2	LEVEL 3	COMMENT	
<b>Setup measurement</b>	Needle model	TP09 TP07	<i>Selects the type of needle used</i>	
	Needle serial		<i>The serial number of the needle</i>	
	Heater Ohm/m	70 – 95 $\Omega$	<i>Resistance of the heating wire in <math>\Omega</math>/m</i>	
	Heating voltage	1.0 – 4.5 volt	<i>Voltage for heating, increased in steps of 0.5 volt</i>	
	Interval	100 – 1000 s	<i>Duration of the measurement, increased in steps of 100 seconds</i>	
	Unit	$\lambda$ W/(m·K) $\lambda$ BTU/(hr·ft·°F) R m·K/W R hr·ft·°F/BTU		
	Project name		<i>Name of the measurement campaign</i>	
	Operator ID		<i>Name of the operator using the MTN system</i>	
	Backlight	ON or OFF	<i>Turns the LCD backlight on or off</i>	
	Date and time	HH:MM MM-DD-YYYY	<i>Date and time used by the CRU module</i>	
	Reset CRU to default		<i>Reset the CRU to default settings</i>	
	<b>Start measurement</b>			<i>Measurement starts immediately with stabilizing</i>
		Add measurement information	Depth	<i>Depth of the needle in tested material</i>
		Location	<i>Location where the measurement is performed</i>	
		Remark 1	<i>Additional field for information</i>	
		Remark 2	<i>Additional field for information</i>	
		Remark 3	<i>Additional field for information</i>	
		Store data	ENTER	<i>Store data</i>
<b>Data access</b>	Browse through data	01 - 50	<i>Stored measurements</i>	
	Clear all data			
<b>Power off</b>	Power off			

## 7.6 Software

First the CRU02 program should be installed on the PC, to allow transferring data from CRU02 to the PC.

1. Insert the USB flash drive in the computer
2. Select 'setup\_CRU02'
3. Run the software and install additional drivers
4. A shortcut will be placed on the desktop
5. The software is now installed and can be run from the computer

For available software / firmware updates, please check:

<http://www.hukseflux.com/page/downloads>

## 8 Data Transfer, Archiving and Review

### 8.1 Connecting CRU02 and PC, downloading data to a PC

The CRU02 and the PC can be connected using the USB port that is hidden behind the bottom cover of the CRU02. The cover can be removed by pressing the two small buttons at the sides of it.

Once software and drivers have been installed, user should connect the CRU02 unit to the PC, open the CRU02 software on the PC and select the correct COM-port for communication under the 'Options' tab (a virtual COM port will be made by the software drivers).

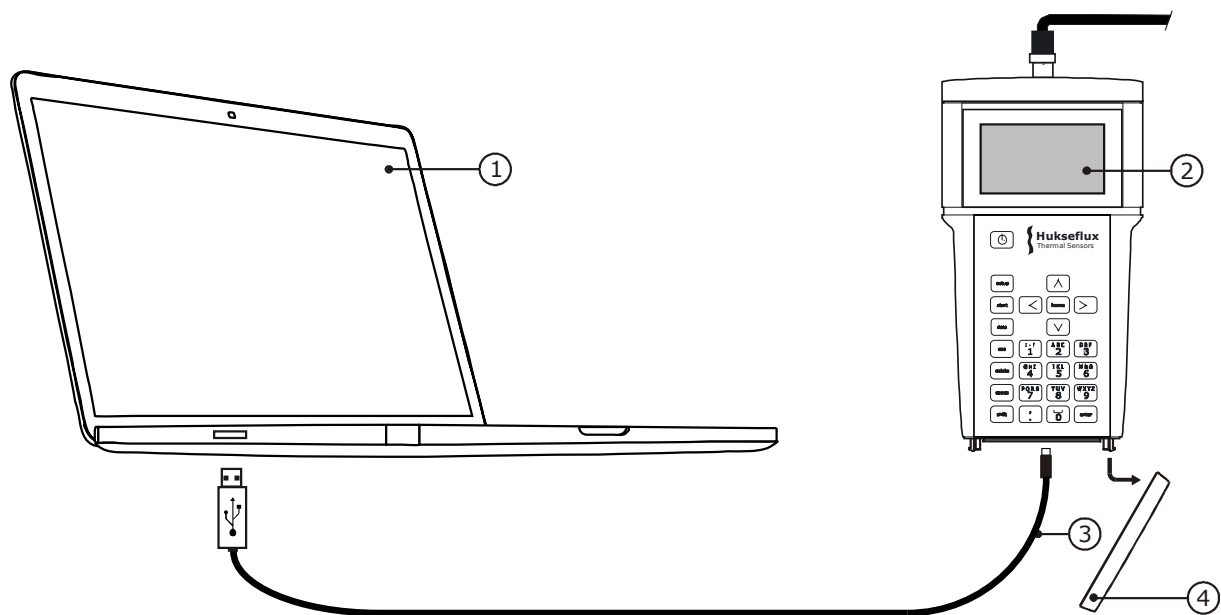

**Figure 8.1.1** For additional quality insurance, the data of the measurements can be stored and downloaded to the PC, and reviewed using the CRU02 software (1). The CRU02 (2) can be connected to the PC by removing a cover (4) and connecting the USB cable on both sides (3). Visual data review is required by ASTM.



## 8.2 Reviewing Data in the Hukseflux CRU02 manager

For reviewing data and troubleshooting possible problems the Hukseflux CRU02 Manager can be used.

Connect the CRU02 to the computer using a USB cable.  
Press "Read memory".

The menu consists of four windows.

### 1 Summary:

This window shows the value of all the important parameters, in particular thermal conductivity and standard deviation. The value of the standard deviation must be smaller than 0.1 for quality assurance.

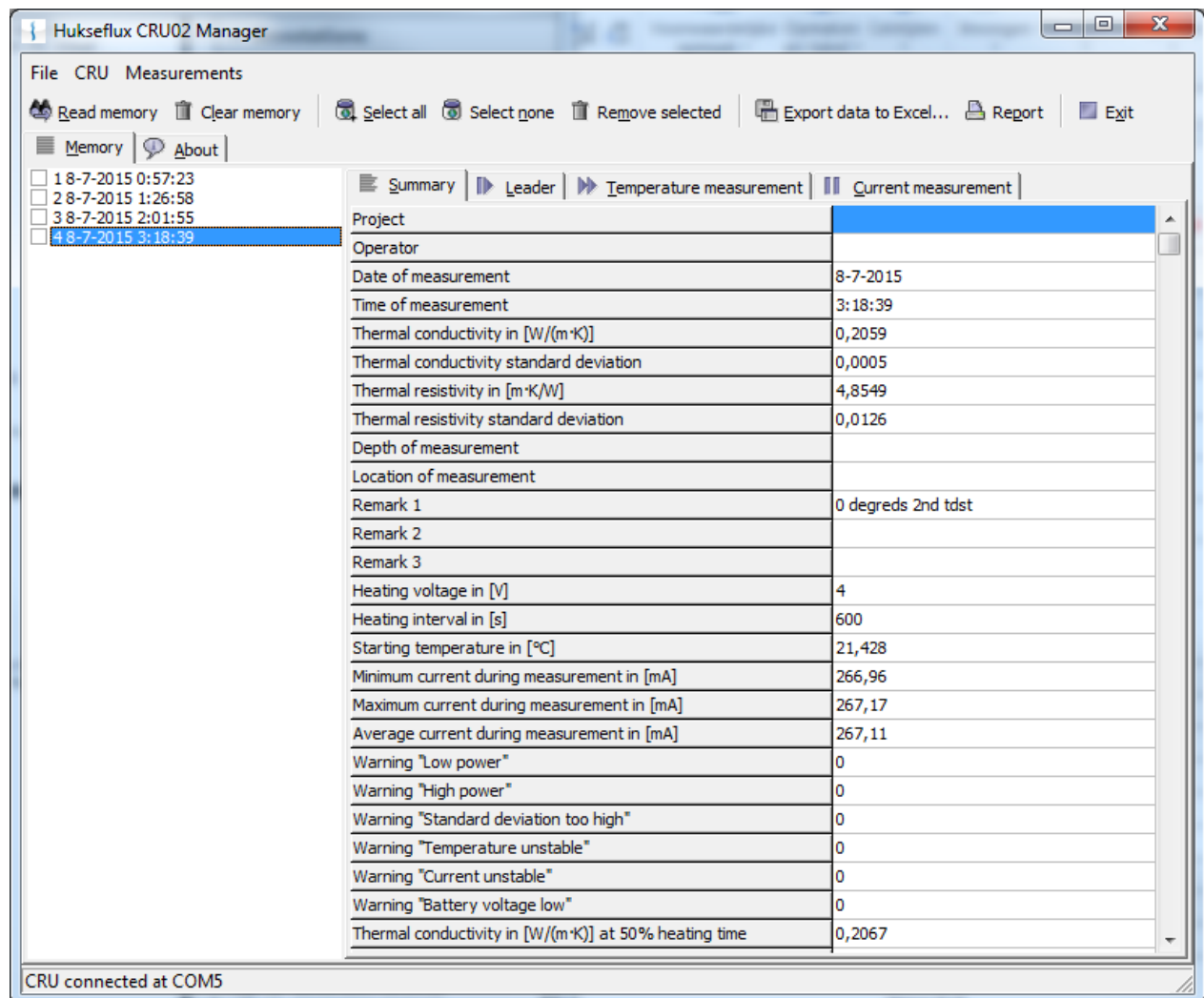

**Figure 8.2.1** Main window in the CRU02 program, showing a summary of the measurement, including all text that has been added

**2 Leader:**

This window shows the temperature during one minute before the measurement. The temperature should be stable. A rule of thumb is that the temperature change in the leader should be smaller than 0.1 °C. In case the fluctuations are too high, you should wait more time before starting the measurements so that the needle can stabilize in the material and increasing the power level.

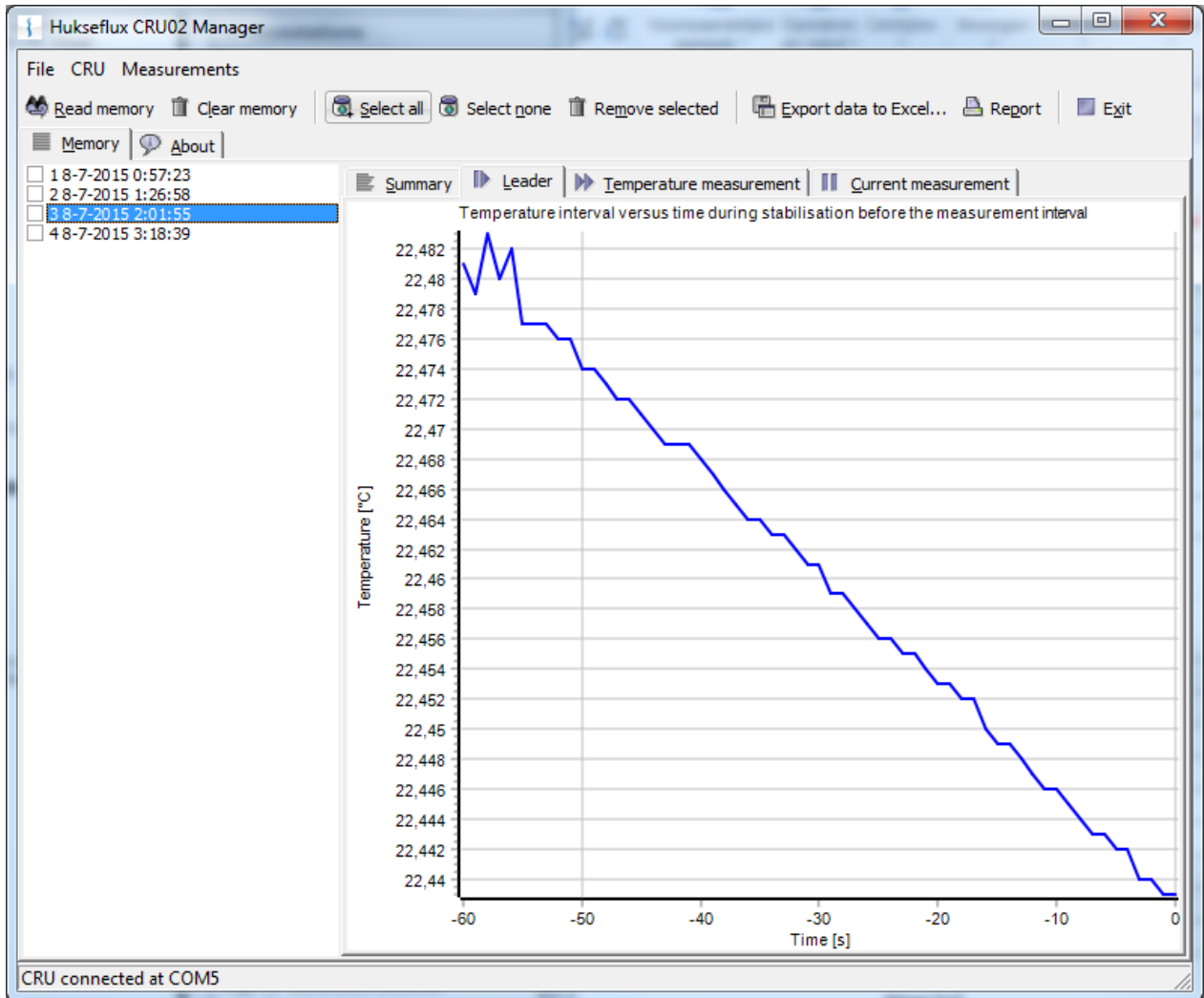

**Figure 8.2.2** Leader window in the CRU02 program, showing the temperature during one minute before the measurement

### 3 Measurement window:

This represents the temperature versus time.

In the bottom of the screen either a linear or logarithmic time scale can be selected.

Temperature should increase and not fluctuate. When the curve is fluctuating too much, it means that there is not enough equilibrium with the medium or/and that the sensor is moving. wait longer before starting the measurements and/or apply higher power.

The last part of the temperature versus logarithmic time curve should be straight. When the last part of this line is not straight, the calculated thermal conductivity value will be wrong. This can indicate two different facts: the flux has reached the media container and/ or, in case of wet soil, it can indicate that convection has started. In these cases, reduce the heating time to 300 sec and/or increase the mass of the media to measure so that it takes longer to reach the boundaries.

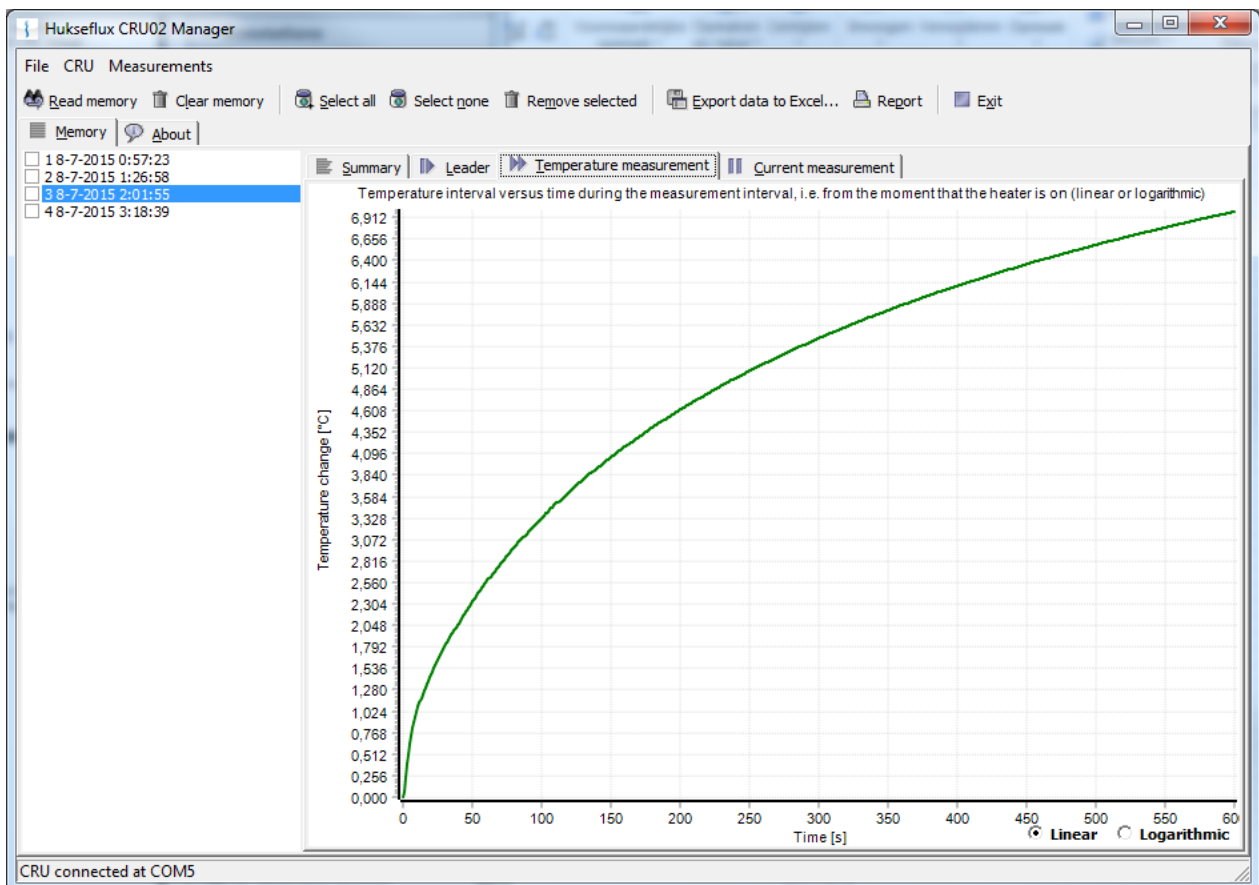
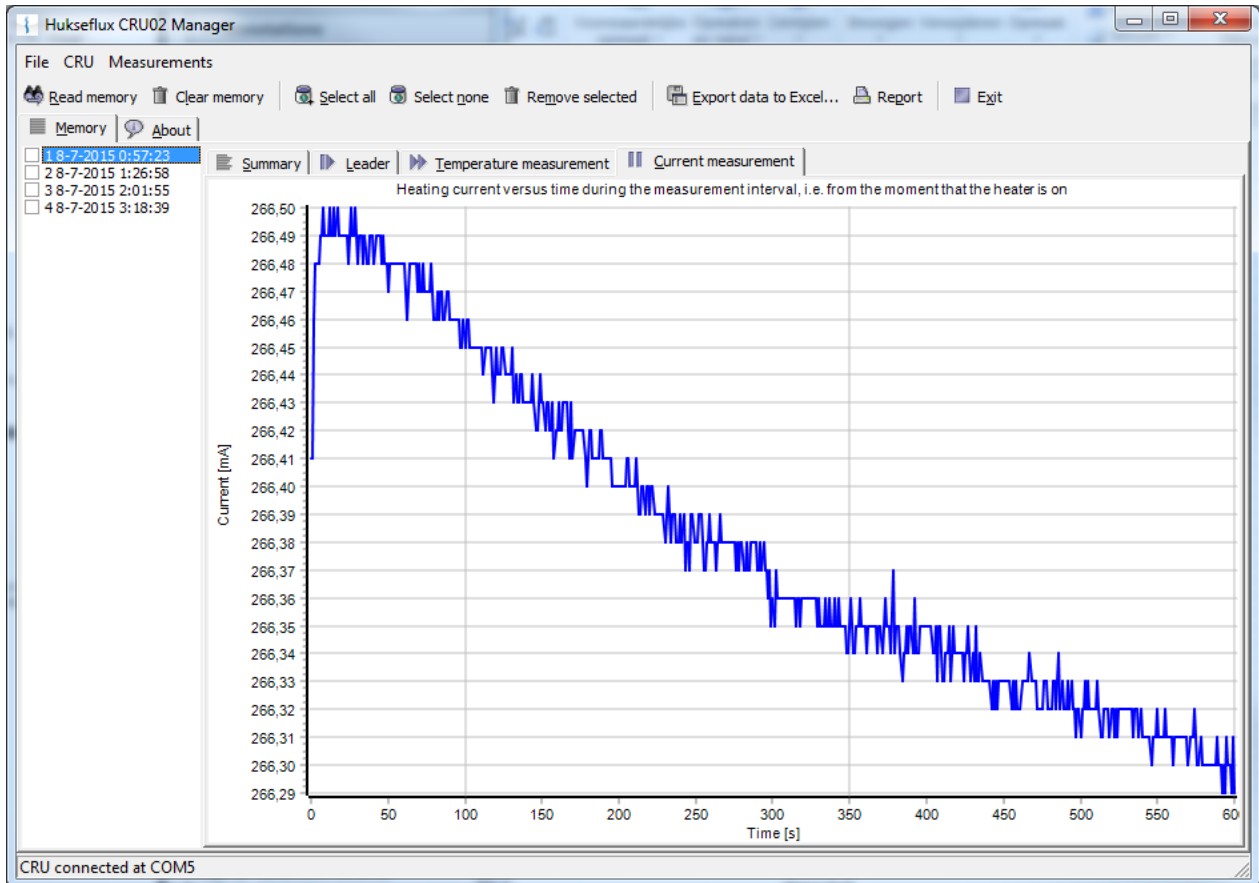

**Figure 8.2.3** Measurement is the main review window in the CRU02 program. It shows the temperature versus the logarithm of time. The last half of this line should be straight

#### 4 Heater current:

Heater current should be constant; deviation <1 mA.

When heater current is not constant, the battery has problems or need to be charged.



**Figure 8.2.4** Heater current window, showing the value of the current going to the heater of the needle

### 8.3 Reviewing Data in Excel

Hukseflux has an Excel template which can be used for detailed analysis of the measurement data.

This template offers the possibility to select different time intervals for the thermal conductivity calculations.

It also has the option to change the Re value of the probe used for data analysis.

The analysis sheet consists of three tabs. The "results" tab gives an overview of the measurement results. Parameters in the yellow cells can be changed.

Data analysis step by step:

1. Export the data from Hukseflux CRU02 Manager to Excel using "Export data to Excel..."
2. Copy the data of the measurement to be analysed to the "raw data" tab of "FTN02 MTN02 calculation sheet vXXX.xlsx" (see figure 8.3.1)

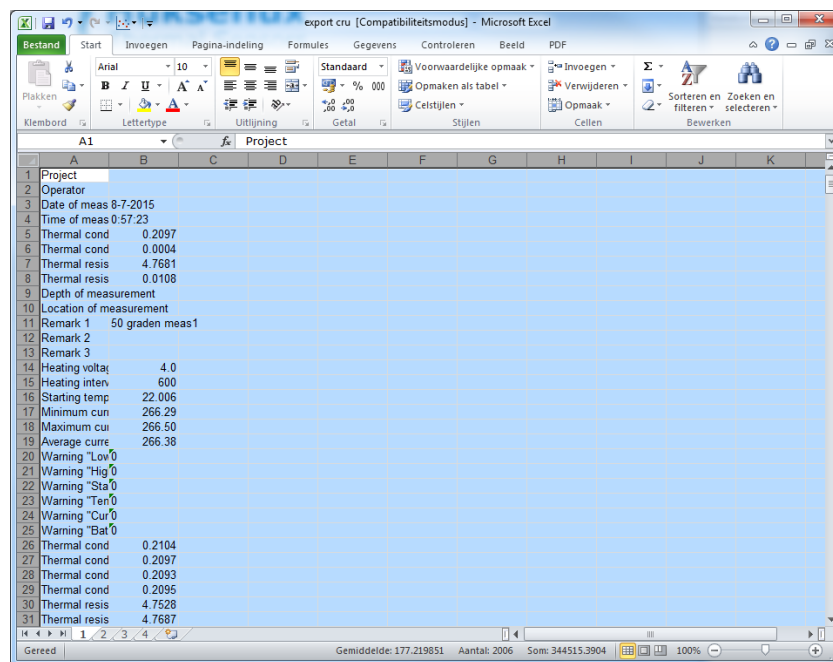

	A	B	C	D	E	F	G	H	I	J	K
1	Project										
2	Operator										
3	Date of meas	8-7-2015									
4	Time of meas	0:57:23									
5	Thermal cond	0.2097									
6	Thermal cond	0.0004									
7	Thermal resis	4.7681									
8	Thermal resis	0.0108									
9	Depth of measurement										
10	Location of measurement										
11	Remark 1	50 graden meas1									
12	Remark 2										
13	Remark 3										
14	Heating voltat	4.0									
15	Heating inten	600									
16	Starting temp	22.006									
17	Minimum cur	266.29									
18	Maximum cur	266.50									
19	Average cur	266.38									
20	Warning "Low"										
21	Warning "Hig"										
22	Warning "Sta"										
23	Warning "Ten"										
24	Warning "Cur"										
25	Warning "Bat"										
26	Thermal cond	0.2104									
27	Thermal cond	0.2097									
28	Thermal cond	0.2093									
29	Thermal cond	0.2095									
30	Thermal resis	4.7528									
31	Thermal resis	4.7687									

**Figure 8.3.1** Using the "Copy" button in the "Data" menu, the measurement data can be copied to the analysis sheet using the "paste" function. Excel the user can make data analysis and presentation of his own choice

3. View the graphs to check irregularities in the measurement
4. Input the time interval to be used in cell C4 and C5. The red diamond in the measurement graph indicate the start and end of the interval visually. The linear portion of the graph should be used. For an example see figure 8.3.2

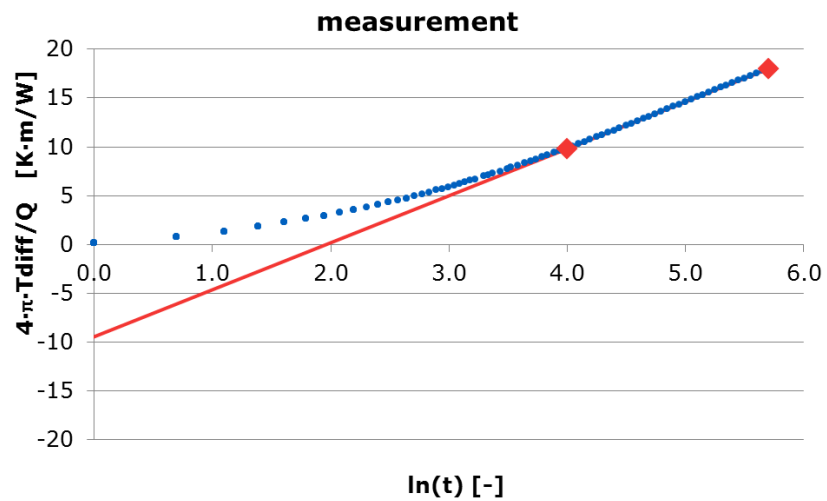

**Figure 8.3.2** Measurement graph with data interval  $\ln(t_{begin})=4.0$  and  $\ln(t_{begin})=5.7$ .

5. The measurement results, used parameters, measurement details and remarks regarding the measurement are shown in the results tab.

## 9 Maintenance and Storage

MTN02 does not need a lot of maintenance.

It is important to take care that the day before use the battery is charged. See the appendix on charging.

After use the equipment can be cleaned using water.

CRU02 should be stored in a dry place.

If you plan to store the CRU02 for longer periods, make sure that the battery is not fully charged or empty. This can lead to damage to the battery.

Usually errors in functionality will appear as unreasonably large or small measured values. As a general rule, this means that a critical review of the measured data is the best form of preventive maintenance.

At regular intervals the quality of the cables and probe should be checked. On a regular interval the calibration should be checked.

**Table 9.1** *Recommended schedule for calibration of MTN02*

Every 6 months	Perform calibration of the entire system using glycerol with fibre or CRC04
Every 2 years	Perform calibration of the MTN02 / CRU02 at Hukseflux

The functionality of MTN02 can be checked with a calibration of the entire system using glycerol with fibre or CRC04. This procedure is explained in section 7.4.

The advice is to send CRU02 to Hukseflux for recalibration every 2 years. The date of the last factory calibration is displayed for several seconds on the LCD screen of CRU02 after starting up.

During factory recalibration the temperature, current and time measurement and the voltage output are recalibrated. The CRU02 will be returned with a new calibration certificate.

## 10 Delivery and Spare Parts

MTN02 delivery includes the following items:

- Manual MTN02
- CRU02 Control and Readout Unit
- IT03 Insertion Tool
- TP07 Thermal Properties Sensor
- PT02 Protection tube
- TC02 Transport Casing
- JR01 Jar for glycerol, with polyester fibres
- Calibration certificate for TP07
- Factory Test Certificate for CRU02
- CRU02 Manager Software on Hukseflux USB flash drive
- TP07 Thermal Properties Sensor (1 piece as spare)
- CA02 Car Adapter for 12 to 24 VDC
- WSA02 Wall Socket Adapter for 220 or 110 VAC
- USB Cable for CRU02 to PC connection

The following spare parts can be obtained at Hukseflux:

- Connector for CRU02

Delivery does NOT include glycerol fluid. This has to be locally obtained by the customer.

MTN02 software can be updated by the customer. New software versions are available on a regular basis.



## 11 Appendices

### 11.1 Appendix on modelling TP07 behaviour

Modelling a finite line source is the subject of many scientific publications. Various efforts have been made to estimate errors and to improve the model such that a more accurate measurement can be attained.

The analytical solution to the problem is known. This involves the fact that the probe has a certain geometry, no significant conduction along the probe itself and has different thermal properties than the medium. Also it assumes that there is a certain constant contact resistance between the probe and medium. The equation is given in Kosky and McVey.

On the other hand in most applications the ideal model, without considering probe thermal properties and contact resistance is used:

$$\Delta T = (Q / 4 \pi \lambda) (\ln t + B) \quad 11.1.1$$

It turns out that also if contact resistance and different thermal parameters are involved, the long time solution of the analytical model and the ideal model lead to the same result for  $\lambda$ . The only difference is that B is larger in the analytical model because of the contact resistance. In other words, the effects of the probe thermal properties and contact resistance are no longer visible some time after the heating has started. Because B cancels from the equation for determination of  $\lambda$ , 11.1.1 is still applicable. For the same reason the use of filling materials is allowed.

$$\lambda = (Q / 4 \pi \Delta T) \ln(t_2 / t_1) \quad 11.1.2$$

The normal transient period under ideal conditions is:

$$t_{\text{transient}} = 10 D^2 / a \quad 11.1.3$$

Under ideal conditions this means that the transient time is proportional to the soil thermal diffusivity  $a$ , and the probe cross section ( $D$  is the diameter). The only consequence of the addition of contact resistance and probe thermal properties is that the transient period will take longer.

The remaining measurement error has been analysed by various authors. Conclusions are that the main parameters determining the transient period are  $R_{\text{cont}}$ , the contact resistance, and  $C_{\text{v needle}}/C_{\text{v med}}$ , the ratio of the volumetric heat capacities. The higher the contact resistance and the lower the medium volumetric heat capacity, the longer the transient time will be.

Theoretically, it would be best to take the measurement time of more than 10 minutes. This is not possible because of three reasons:

1. the temperature rise becomes too small relative to the temperature changes induced by outside sources.
2. there is a risk that the boundary conditions of the sample start playing a role.
3. there is a risk that the total energy that is released into the medium becomes so large that the condition of the medium is affected.

Various attempts have been made to simplify the measurement procedure. There has been limited success. The general recipe now is: take a look at the contact resistance. If a large contact resistance is expected, and the medium allows the use of contact fluid or grease (like toothpaste, agar gel, glycerol, silicone glue or Vaseline) can be considered. This is often applied when analysing rock samples.

This means that for all practical purposes for the measurement of thermal conductivity's the model of formula 1.2 can be used.

Regarding the accuracy of the measurement; the estimate of  $\pm (6\%+0.04) \text{ W}/(\text{m}\cdot\text{K})$  for MTN02 is derived from various literature sources. For more details, see the list of references.

## **11.2 Appendix on ASTM and IEEE standards**

With MTN02 it is possible to perform measurements in accordance with the ASTM and IEEE standards. These standards are:

ASTM D5334-14 Standard Test Method for Determination of Thermal Conductivity of Soil and Soft Rock by Thermal Needle Probe Procedure

This standard can be obtained from ASTM. For information see <http://www.astm.org>.

IEEE Std 442-1981(reaffirmed 2003), IEEE Guide for soil Thermal Resistivity Measurements.

Resistivity is the inverse of the conductivity. This parameter is not used in the text of this manual.

The IEEE standard can be obtained from IEEE. For information see <http://www.ieee.org>.

For full compliance with ASTM, it is necessary to follow the procedures described in the standard. Hukseflux suggests allowing slightly modified procedures. The described deviations are positively affecting the quality and practicality of the measurement, and altogether compliance with the standards can be stated when following the recommendations in this manual in addition to those in the standards.

The IEEE standard is specifically written for application in the power industry, for estimating thermal budgets of electrical cables. There is a clear distinction between field

measurements and laboratory measurements. In general FTN02 will be used in field situations. Hukseflux can offer alternative needle designs for laboratory use.

### 11.3 Appendix on insertion of the needle into hard soils

During the measurement, the TP07 needle should be completely in contact with the medium. It should be in a perfectly static position, with no possibility of movement. Usually this is achieved by fixation of the needle.

In case of soft media the needle often can be inserted without any particular trouble. In case of hard media like hard soil, a hole may be pre-drilled.

There are two possibilities for pre-drilling that are shown in table 11.3.1.

**Table 11.3.1** *Two possibilities for pre-drilling*

<p>In case of modestly hard media: 3.5 mm diameter drills can be used to prepare the path for the TP07 needle. Normally the heating cycle time can remain unchanged. The measurement accuracy will not be affected.</p>	<p>To improve contact between needle and medium, the medium around the TP07 needle is typically compressed manually. The degree of compression should be no more than that of the undisturbed medium.</p>
<p>A hole diameter of up to 3.5 mm is recommended, up to 0.5 cm cm is allowable in extreme cases. The heating cycle time must be increased. The measurement accuracy can be maintained by reviewing the data.</p>	<p>In this case a hole is created that has a significantly larger diameter than that of the TP07 needle. In this case the use of contact material is necessary.</p>

However, in order to make sure that the contents of the hole do not play a role in the measurement, three measures need to be taken.

**Table 11.3.2** *Measures taken after pre-drilling with a larger diameter than the probe*

<p>After inserting the TP07 needle the hole must be filled with contact material. This can either be the original medium, now loose, or a gel (solidified agar) or paste (any white toothpaste or silicone glue). In any case the presence of fluid materials that might have thermal convection, in the hole must be avoided.</p>	<p>Loose medium can be compressed as much as possible around the TP07 probe by hand. For dry or semi-moist media, toothpaste is preferred over silicone based thermal paste because of its relatively high thermal conductivity.</p>
<p>The heating cycle duration is increased from the usual 300 with the square of the diameter to a maximum of approximately 600 s.</p>	<p>This is to make sure that the heat generated by the TP07 extends well beyond the diameter of the hole</p>

## 11.4 Appendix on typical soil thermal properties

**Table 11.4.1** A list of typical values of thermal properties of various materials. This list is only indicative and can serve for estimating the medium thermal conductivity

	Thermal conductivity @20°C W/(m·K)	Density @20°C Kg/m <sup>2</sup>	Volumetric heat capacity @20°C 10 <sup>6</sup> J/m <sup>2</sup>	Thermal diffusivity @20°C 10 <sup>-8</sup> m <sup>2</sup> /s
Air	0.025	1.29	0.001	1938
Glycerol	0.29	1260	3.073	9
Water	0.6	1000	4.180	14
Quartz	3	2600	2.130	141
Concrete	1.28	2200	1.940	66
Marble	3	2700	2.376	126
Sand (dry)	0.35	1600	1.270	28
Sand (saturated)	2.7	2100	2.640	102
Glass pearls (dry)	0.18	1800	1.140	16
Glass pearls (saturated)	0.76	2100	2.710	28

**Table 11.4.2** Reported values, as known to the author, of thermal conductivity in different soil types in W/(m·K).

Range of all reported values for granular soils	0.15 to 4
Saturated soil	0.6 to 4
Sand perfectly dry	0.15 to 0.25
Sand moist	0.25 to 2
Sand saturated	2 to 4
Clay dry to moist	0.15 to 1.8
Clay saturated	0.6 to 2.5
Soil with organic matter	0.15 to 2
Solid Rocks	2 to 7
Tuff (porous volcanic rock)	0.5 to 2.5

## 11.5 Appendix on glycerol / glycerine

The procedure for calibration relies on the use of glycerol. This substance is also known under the name glycerine. Chemical datasheets can be found in separate appendices (11.12 and 11.13).

Glycerol is safe. It can be bought in every pharmacy.

During calibration the glycerol is supposed to be static, in other words, not to flow. This is why at Hukseflux the glycerol is mixed with polyester fibres. This suppresses convection. At the same time, the fraction of polyester fibres is so low (less than 1% by mass) that the thermal conductivity of the glycerol is not affected.

The properties of glycerol at 0 to 1 mass % plastic fibres closely resemble those of glycerol:

Thermal conductivity: 0.29 W/(m.K), at 20 °C.

## 11.6 Appendix on electrical connection of TP-CRU02



Putting more than 5 Volt across the heater may result in permanent damage to the sensor. The input voltage for charging should not exceed 5 VDC as it may lead to damage of the CRU02 battery.

In case the user chooses to replace a TP needle or makes other adjustments to MTN02, the following wire colours need to correspond in order for the system to function properly:

**Table 11.6.1** Connection and colour codes of CRU02, cable and needle wires

CRU02	CABLE	TP / ADAPTER
Yellow (heater)	Yellow	TP Yellow
Brown (heater)	Brown	TP Yellow
White (1)	White	TP Red
Red (2)	Red	TP Red
Blue (3)	Blue	TP White
Green (4)	Green	TP White

In case the user chooses to replace a connector and / or cabling, the following applies:

The connectors that are used by Hukseflux for TP and CRU02 are manufactured by Binder. In order to protect the cables, these are first covered by a sleeve. The sleeve is installed by thermal shrinkage.

**Table 11.6.2** Connectors for use with MTN02

TYPE	CODE
Normal male connector to CRU02 cable	S 104 A055-130 with internal part E3 104.2/6.7 + B
Normal female chassis part in MTN02	DEE 104 A055-130 with 104.551 spacer 6 mm (for attachment to a thin wall)

## 11.7 Appendix on trouble shooting

**Table 11.7.1** Extensive checklist for trouble shooting

PROBLEM	CAUSE	SOLUTION
Startup a message `No probe connected` appears	The probe is not connected properly to the MTN02	Connect the probe properly to the connector blocks, check cables for breaches.
On startup a message "battery voltage too low, connect adapter" appears	The voltage of the batteries is too low.	Recharge the batteries.
The results of my measurements are consistently too high or too low	The MTN02 is not properly calibrated.	Recalibrate the MTN02 see chapter 7.4.
	The probe resistance has not been stored in the CRU02.	Enter the probe resistance as engraved in probe see chapter 7.1
The duration of the measurement is extremely long (27680s)	The values for the presets have to be confirmed.	In the `setup` menu confirm all preset values.
The standard deviation often is more than 0.1 W/(m·K)	The heating power of the probe is too low	Increase the voltage of the heater in the menu `setup`
The display is not readable	The contrast is set either too high or too low. Ambient light is insufficient.	In menu `setup` `display options` adjust contrast or turn on the backlight
	The USB cable is not properly connected.	Check the connection of the USB cable.

## 11.8 Appendix on replacement of a TP

See the chapter on electrical connections in the appendices when replacing the TP needle.

Carry out the following steps to replace TP07:

- Unscrew the top of IT03. This can be done by using a screwdriver (base diameter 0.5 mm). Put the shaft of the screwdriver through the hole on top of IT03 and turn  
Inside IT03 is the connector block that connects the connector to the TP09
- Disconnect the wires of the old needle from the connector block
- Use a wrench (17 mm) to unscrew the needle from the bottom of IT03
- Remove the old needle and its wires from IT03 and replace it with the new needle
- Connect the wires of the new needle to the connector block
- Put the top back on IT03 and fasten it
- Fasten the new needle



The resistance value of the new TP must be entered. If this value is not known, one can work with the old value (somewhere between 70 and 95 Ohm/m). In case of doubt, choose 80 Ohm/m. The obtained values can always be corrected afterwards.

## 11.9 Appendix on battery charging

The CRU02 operates with a 3.7 volt li-ion battery pack. The internal CRU02 charging circuitry regulates the charging and makes sure the battery is not over-charged, which can permanently damage the battery. A full recharge can be done in 11 hours with any source that can supply 5 VDC and 1 A. This can be achieved using either the WSA02, as well as CA02.

Measurements can be performed after one hour of charging. The red charging unit switches off when CRU02 is fully charged.

## 11.10 Appendix on downloading new software versions

The CRU02 is designed such that new software can be installed at no cost. For available software / firmware updates, please check: <http://www.hukseflux.com/page/downloads> Software can be downloaded from a PC to the CRU02. This can be done using the "CRU02 Service" software. Go to 'Tools' and press 'Flash firmware...'. The new firmware can be selected and will be uploaded to the CRU02.

## 11.11 Appendix on literature references

The following literature gives a good overview of the Non-Steady-State Probe measurement technique.

Application of Parameter Estimation Techniques to Thermal Conductivity Probe Data Reduction, Koski, J. A., McVey, D. F., Thermal Conductivity 17, Plenum Press New York, 1986, pages 587-600.

Determination of the Thermal Conductivity of Moist Porous Materials near The Freezing Point, Van Haneghem, I. A., Van Loon, W. K. P., Boshoven, H. P. A., High Temperatures-High Pressures, 1991, Volume 23, pages 157-162.

Error Analysis of the Heat Pulse Probe for Measuring Soil Volumetric Heat Capacity, Kluitenberg, G. J., Ham, J. M., Bristow, K. L., 1993, Soil Science Society of America Journal 57:1444-1451

Standard Test Method for Determination of Thermal Conductivity of Soil and Soft Rock by Thermal Needle Probe Procedure, American Society for Testing and Materials, D5334-14, 2014.

IEEE Guide for Soil Thermal Resistivity Measurements, The Institute of Electrical and Electronics Engineers Inc, IEEE Std 442-1981(03), 2003

## 11.12 Glycerol Material Safety Data Sheet (93 / 112 EC)

This safety sheet is a copy of the Material Safety Data Sheet Version according to 93/112 EC of 10-08-2000 of the company Ephuysen Chemie. The user is responsible for obtaining the latest Version of this sheet from the manufacturer when purchasing glycerol.

### 1 identification of the substance / preparation and of the company/ undertaking

- Production details -
- Trade Name: Glycerine
- Article Number: 013311
- Manufacturer / Supplier:  
 Ephuysen Chemie N. V.  
 Noordeweg 3  
 3336 LH Zwijndrecht  
 The Netherlands  
 Tel: 00-31-78-612702 Fax: 00-78-6121129  
 e-mail [ppelt@ephuysen.com](mailto:ppelt@ephuysen.com)
- Further information available from: environmentally Department
- Information in case of emergency: see above

### 2 Composition / information on the ingredients

- Chemical characterisation: Cas No Description: 56-81-5 Glycerol
- Identification numbers: -
- EINECS Number: 200-289-5

### 3 Hazards identification

- Information concerning to particular hazards to man and environment: Not applicable

### 4 First-aid measures

- General information: No special measures required
- After inhalation: Supply fresh air; consult a doctor inn case of complaints
- After skin contact: Generally the product does not irritate the skin
- After eye contact: Rinse opened eye for several minutes under running water
- After swallowing: If symptoms persist consult a doctor

### 5 Fire fighting measures

- Suitable extinguishing agents: Use fire extinguishing methods suitable to surrounding conditions
- Protective equipment: No special measures required

### 6 Accidental release measures

- Person-related safety precautions: Not required
- Measures for environmental protection: Dilute with plenty of water
- Measures for cleaning / collecting: Absorb with liquid binding material (sand, diatomite, acid binders, universal binders, sawdust).
- Additional information: No dangerous substances are released

### 7 Handling and storage

- Handling :-
- Information for safe handling: No special measures required
- Information about fire - and explosion protection: No special measures required
- Storage:
- Requirements to be met by storerooms and receptacles: No special requirements
- Information about storage in one common storage facility: Not required
- Further information about storage conditions: None
- Storage class: -
- Class according to regulation an flammable liquids: void



### 8 Exposure controls / personal protection

- Additional information about design of technical facilities: No further data; see item 7
- Ingredients with limit values that require monitoring at the workplace: 56-81-5 glycerol OEL: 10 mg/m<sup>3</sup>
- Additional Occupational Exposure Limit Values for possible hazards during processing: Glycerine is (almost) odourless. The MAC-value can exceed the limit unnoticed.
- Additional information: The lists valid during the making were used as a basis
- Personal protective equipment: -
- General protective and hygienic measures: The usual precautionary measures are to be adhered to when handling chemicals
- Respiratory protection: not required
- Protection of hands: not required
- Eye protection: Goggles recommended during refilling

### 9 Physical and chemical properties

- Form: viscous
- Colour: Colourless
- Odour: Odourless
- Change in condition: -
- Melting point / Melting range: 18.2 °C
- Boiling point / Boiling range: 290°C
- Flash point: 177 °C
- Ignition temperature: 400 °C
- Danger of explosion: the product does not present an explosion hazard
- Explosion limits:
- Lower: 0.9 Vol%
- Vapour pressure: at 50 °C 0.003 hPa
- Density: at 20 °C 1.26 g/ cm<sup>3</sup>
- Solubility in / Miscibility with water: Fully miscible
- PH value; Not determined
- Viscosity:
- Dynamic: at 20 °C 106.9 mPas

### 10 Stability and reactivity

- Thermal decomposition / conditions to be avoided: No decomposition if used according to specifications
- Dangerous reactions: No dangerous reactions known
- Dangerous decomposition products: No dangerous decomposition products known

### 11 Toxicological information

- Acute toxicity: LD/ Lc50 values relevant for classification: 56-81-5 glycerol Oral LD50: 250 mg/kg(mus)
- Primary irritant effect:
- On the skin: It is not irritating
- On the eye: No irritating effect
- Sensitisation: No sensitisation effects known.
- Additional toxicological information: When used and handled according to specifications, the product does not have any harmful effects to our experience and the information provided to us. The substance is not subject to classification according to the latest Version of the EU lists.

### 12 Ecological information

- Ecotoxicological effects:
- Aquatic toxicity: 56-81-5 glycerol LC50/24 h: > 5000 ppm (fish)
- General notes: generally not hazardous for water

**13 Disposal considerations**

- Product
- Recommendation: Smaller quantities can be disposed with household waste
- Uncleaned packaging
- Recommendation: Disposal must be made according to official regulations
- Recommended cleansing agents: Water, if necessary together with cleansing agents.

**14 Transport information**

- Land transport ARD / RID (cross border)
- UN-Number: -
- Hazard label: -

**15 Regulatory information**

- Labelling according to EU Guidelines: The substance is not subject to classification according to EU lists and other sources of literature known to us. Observe the general safety regulations when handling chemicals; the product is not subject to identification regulations under EU Directives and the Ordinance on Hazardous Materials (German GefStoffV).
- National regulations
- Classification according to VbF: Void
- Technical instructions (air): Class Share in %: NK 100.0
- Waterhazard class: Generally not hazardous for water.

**16 Other information**

This information is based on present knowledge. However, this shall not constitute a guarantee for any specific product features and shall not establish a legally valid contractual relationship.

- Department issuing MSDS: Environmentally Department
- Contact: P. van Pelt

### 11.13 International Chemical Safety Card for Glycerol

The following pages contain information on the International Chemical Safety Card for glycerol. The user is responsible for obtaining the latest Version of this card from the glycerol manufacturer when purchasing glycerol.

<b>International Chemical Safety Cards</b>			
<b>GLYCEROL</b>			ICSC: 0624
<b>GLYCEROL</b> <b>Glycerine</b> <b>1,2,3-Propanetriol</b> <b>1,2,3-Trihydroxypropane</b> $C_3H_8O_3$ / $CH_2OH-CHOH-CH_2OH$ <b>Molecular mass: 92.1</b> <b>CAS # 56-81-5</b> <b>RTECS # MA8050000</b> <b>ICSC # 0624</b>			
<b>TYPES OF HAZARD/ EXPOSURE</b>	<b>ACUTE HAZARDS/ SYMPTOMS</b>	<b>PREVENTION</b>	<b>FIRST AID/ FIRE FIGHTING</b>
<b>FIRE</b>	Combustible. Gives off irritating or toxic fumes (or gases) in a fire.	NO open flames.	Powder, alcohol-resistant foam, water spray, carbon dioxide.
<b>EXPLOSION</b>			In case of fire: keep drums, etc., cool by spraying with water.
<b>EXPOSURE</b>		<b>PREVENT GENERATION OF MISTS!</b>	
<b>INHALATION</b>	Cough.	Ventilation.	Fresh air, rest.
<b>SKIN</b>	Dry skin.	Protective gloves.	Remove contaminated clothes. Rinse skin with plenty of water or shower.
<b>EYES</b>	Redness. Pain.	Safety goggles.	First rinse with plenty of water for several minutes (remove contact lenses if easily possible), then take to a doctor.
<b>INGESTION</b>	Nausea. Vomiting.	Do not eat, drink, or smoke during work.	Rinse mouth. Give plenty of water to drink. Rest. Refer for medical attention.

SPILLAGE DISPOSAL	STORAGE	PACKAGING & LABELLING
Ventilation. Collect leaking liquid in covered containers. Absorb remaining liquid in sand or inert absorbent and remove to safe place.	Separated from strong oxidants. Dry.	
<b>SEE IMPORTANT INFORMATION ON BACK</b>		
<b>ICSC: 0624</b>	Prepared in the context of cooperation between the International Programme on Chemical Safety & the Commission of the European Communities © IPCS CEC 1993	

<b>International Chemical Safety Cards</b>		
<b>GLYCEROL</b>		ICSC: 0624
<b>IMPORTANT DATA</b>	<p><b>PHYSICAL STATE; APPEARANCE:</b> <b>HYGROSCOPIC, VISCOUS COLOURLESS LIQUID.</b></p> <p><b>PHYSICAL DANGERS:</b></p> <p><b>CHEMICAL DANGERS:</b> The substance decomposes on heating producing corrosive fumes of acrolein. Reacts with strong oxidants causing fire and explosion hazard. Reacts violently with acetic anhydrides in the presence of a catalyst.</p> <p><b>OCCUPATIONAL EXPOSURE LIMITS (OELs):</b> TLV: ppm; 10 mg/m<sup>3</sup> mist (ACGIH 1995-1996).</p>	<p><b>ROUTES OF EXPOSURE:</b> The substance can be absorbed into the body by inhalation of its mist.</p> <p><b>INHALATION RISK:</b> Evaporation at 20°C is negligible; a nuisance-causing concentration of airborne particles can, however, be reached quickly on spraying.</p> <p><b>EFFECTS OF SHORT-TERM EXPOSURE:</b> The substance irritates the eyes, the skin and the respiratory tract.</p> <p><b>EFFECTS OF LONG-TERM OR REPEATED EXPOSURE:</b></p>
<b>PHYSICAL PROPERTIES</b>	<p>Decomposes below boiling point at 171°C</p> <p>Melting point: 18.2°C</p> <p>Relative density (water = 1): 1.26</p> <p>Solubility in water: miscible</p> <p>Vapour pressure, Pa at 20°C: &lt;0.1</p>	<p>Relative vapour density (air = 1): 3.17</p> <p>Flash point: 177°C.</p> <p>Auto-ignition temperature: 370°C</p> <p>Explosive limits, vol% in air: 0.9-?</p> <p>Octanol/water partition coefficient as log Pow: -1.76</p>
<b>ENVIRONMENTAL DATA</b>		
<b>NOTES</b>		
	Also consult ICSC # 0090, acrolein.	
	NFPA Code: H1; F1; R0	

<b>ADDITIONAL INFORMATION</b>	
<b>GLYCEROL</b>	
<b>ICSC: 0624</b>	
<b>© IPCS, CEC, 1993</b>	
<b>IMPORTANT LEGAL NOTICE:</b>	Neither the CEC or the IPCS nor any person acting on behalf of the CEC or the IPCS is responsible for the use which might be made of this information. This card contains the collective views of the IPCS Peer Review Committee and may not reflect in all cases all the detailed requirements included in national legislation on the subject. The user should verify compliance of the cards with the relevant legislation in the country of use.

## 11.14 EC Declaration of Conformity



We, Hukseflux Thermal Sensors B.V.  
Delftechpark 31  
2628 XJ Delft  
The Netherlands

in accordance with the requirements of the following directive:

2004/108/EC      The Electromagnetic Compatibility Directive

hereby declare under our sole responsibility that:

Product model:      MTN02  
Product type:      Thermal needle system

has been designed to comply and is in conformity with the relevant sections and applicable requirements of the following standards:

Emission:            EN 61326-1 (2013), class B  
Immunity:            EN 61326-1 (2013), industrial  
Report:                15C01131RPT01, 19 August 2015



Eric HOEKSEMA  
Director  
Delft  
03 September, 2015

