

new!

HEXAGON-IMAGING-PAM



Please find this presentation + a datasheet as download link in the "chat"



4 large measuring setups in one device:

- Detached leaved
- Algae samples
- Potted plants
- Plant trays

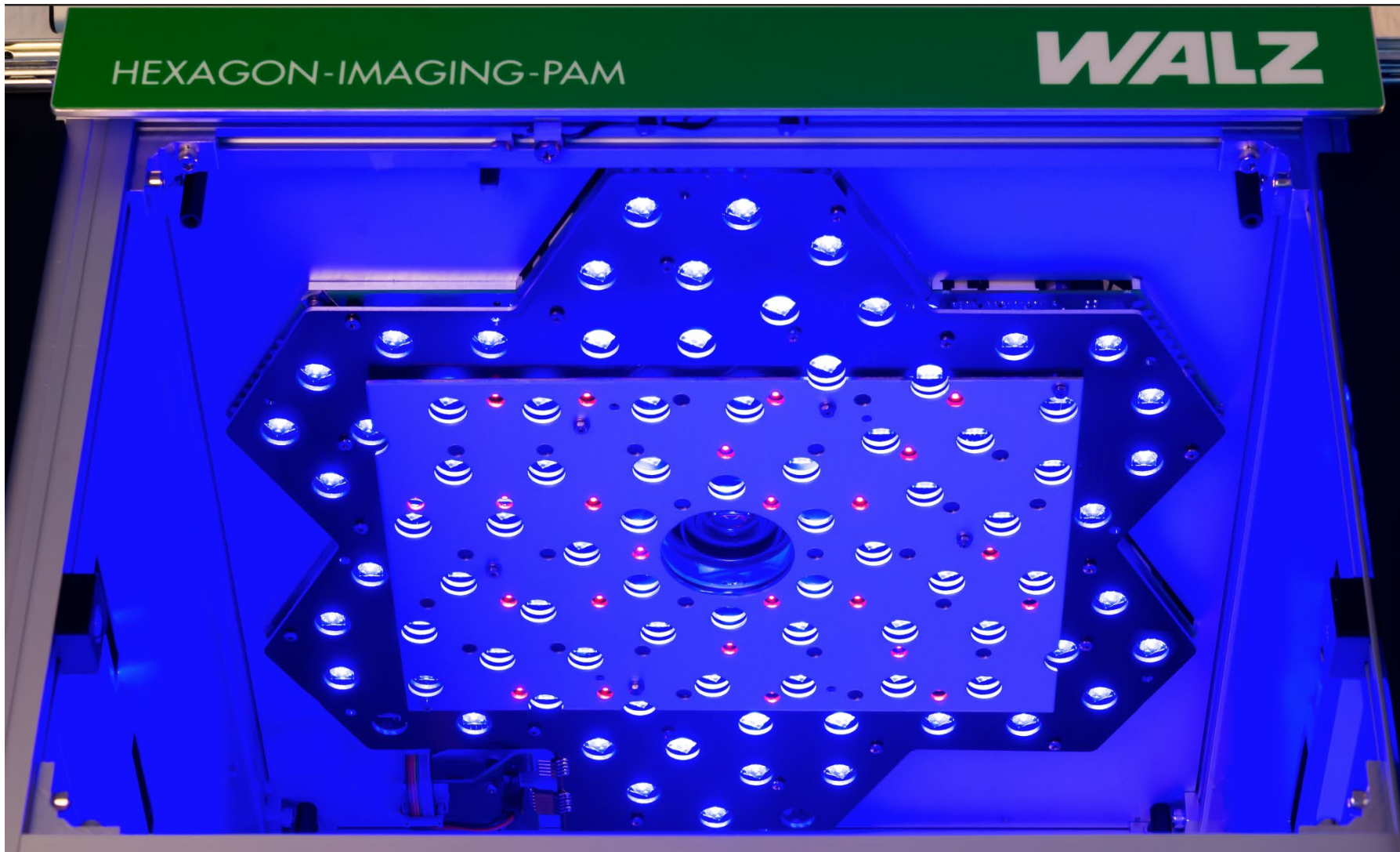

- Cree High power LEDs with powerful 600 W (451 nm)
- 78 LEDs in 6 segments
- Panel design and control for highest homogeneity
- Far red LEDs in 2 separately controlled circles for Fo' work on future applications in progress
- Actinic light intensity up to $2000 \mu\text{mol quanta m}^{-2} \text{s}^{-1}$
- Sat pulse with $4100 \mu\text{mol quanta m}^{-2} \text{s}^{-1}$

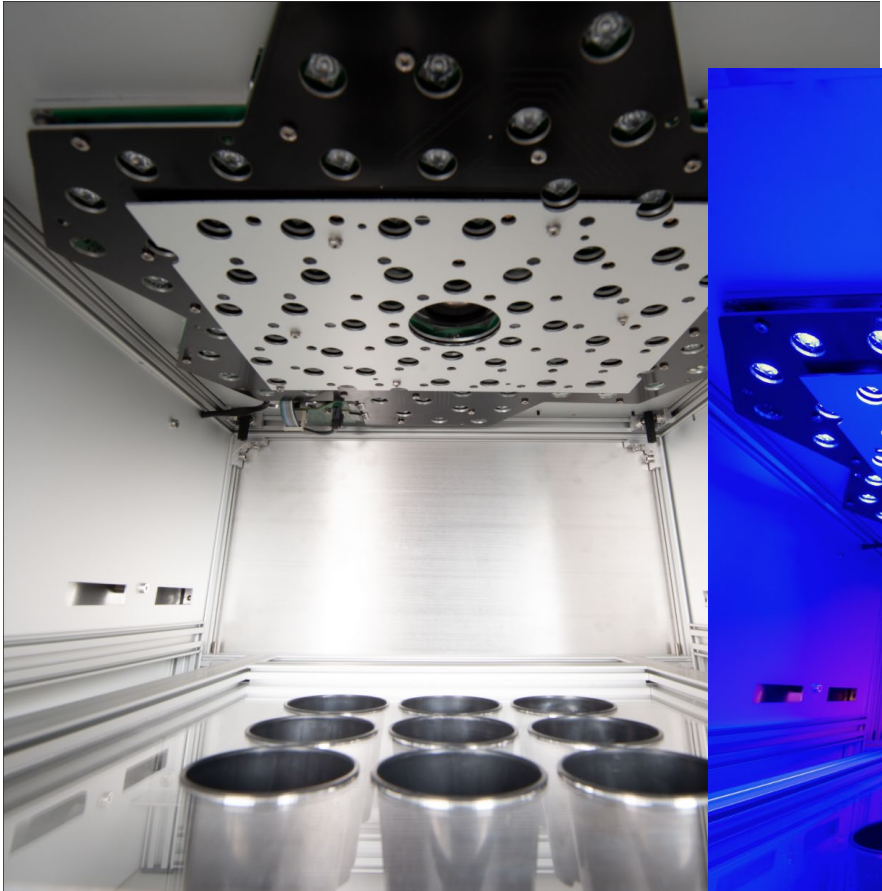

Safety First

The device is protected by a safety shutdown. Shining LEDs are normally not directly visible to the user.

If the door is accidentally opened during an experiment, only the measuring light remains switched on.

Dimensions

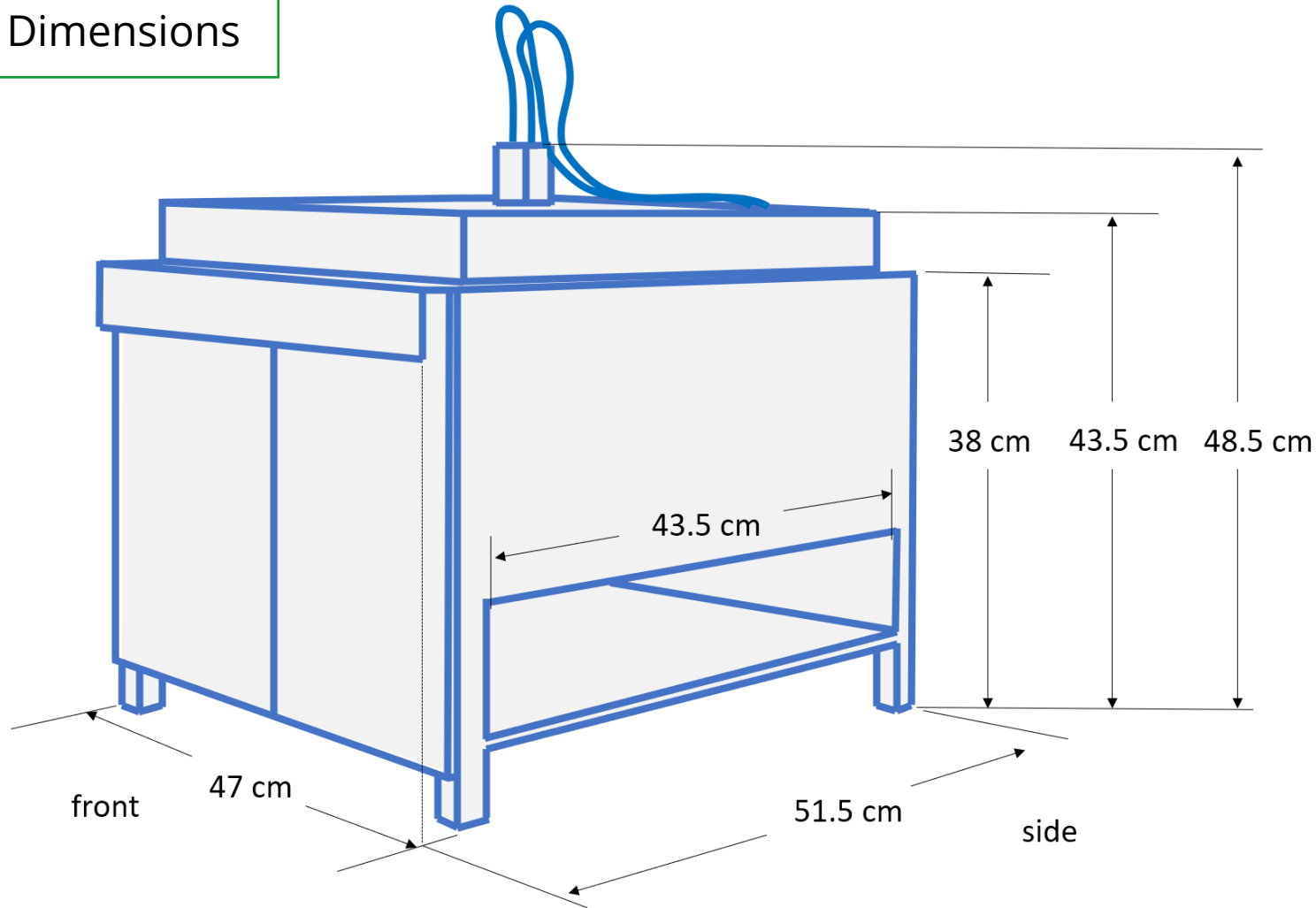

Camera

Sony IMX264 CMOS 2/3" Sensor
 3.45 x 3.45 Pixel size.
 8 mm lens for imaging of 1200 x 1000 px
 in 10-bit color depth

Control computer

Recommended and available as accessory:
 Intel NUC mini-PC with Win 10 OS (please
 inquire specifications)



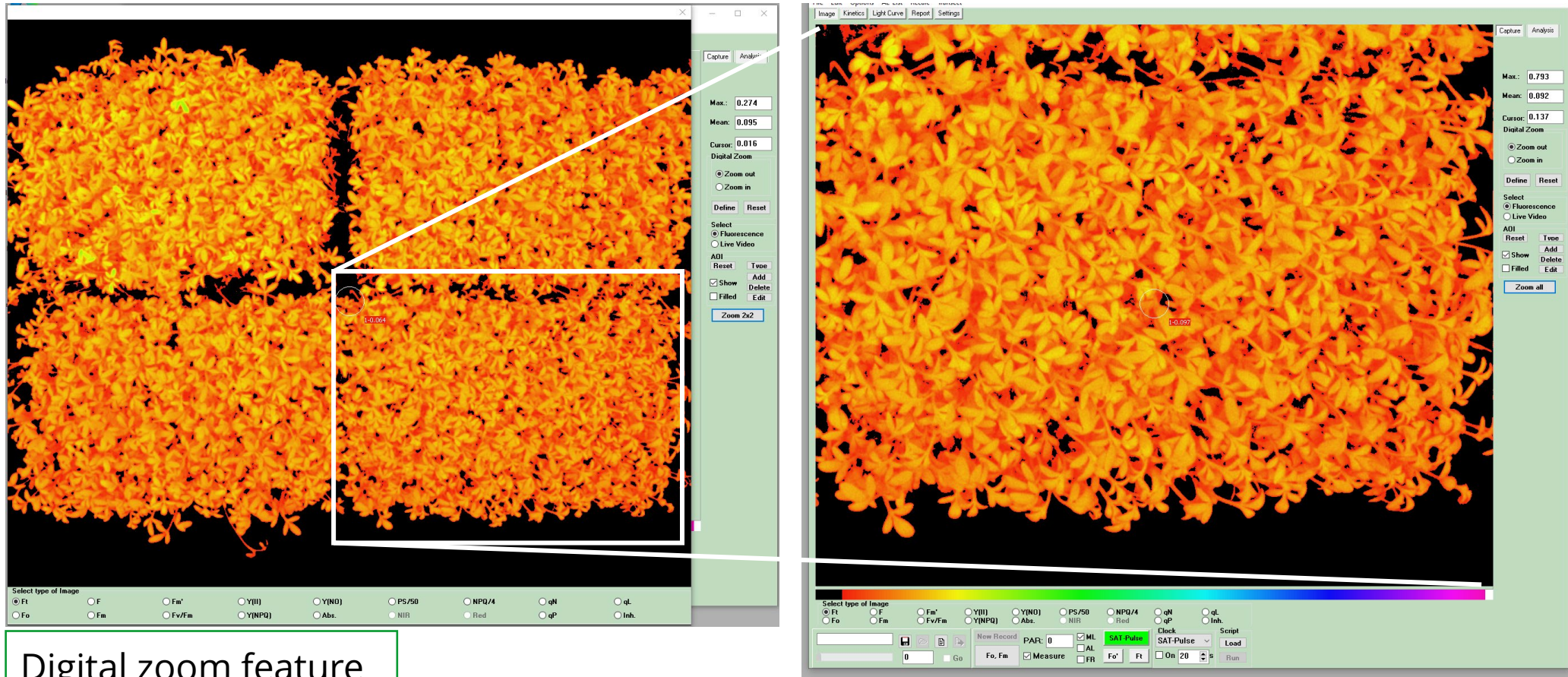

Digital zoom feature

By switching of the pixel binning from 2x2 to 1x1 – loss of sensitivity is automatically compensated by increasing the gain settings (for more details)

New: floating window

Available in *ImagingWin* for HEXAGON-IMAGING-PAM offers a better overview.
Current sample image always shown on left side during the measurement

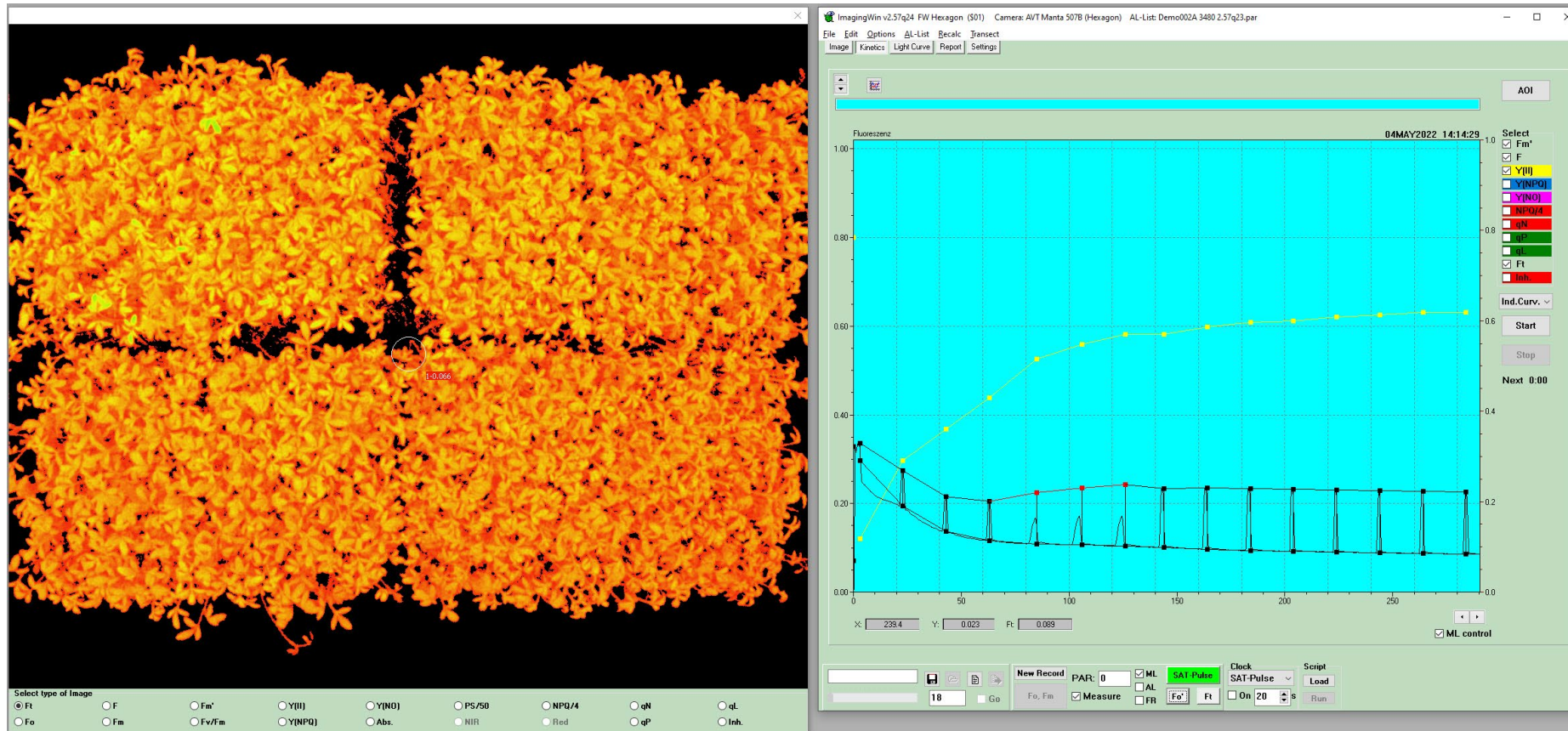

Recommended display
resolution: WQHD
(also called 1440p)
with 2560x1440 px

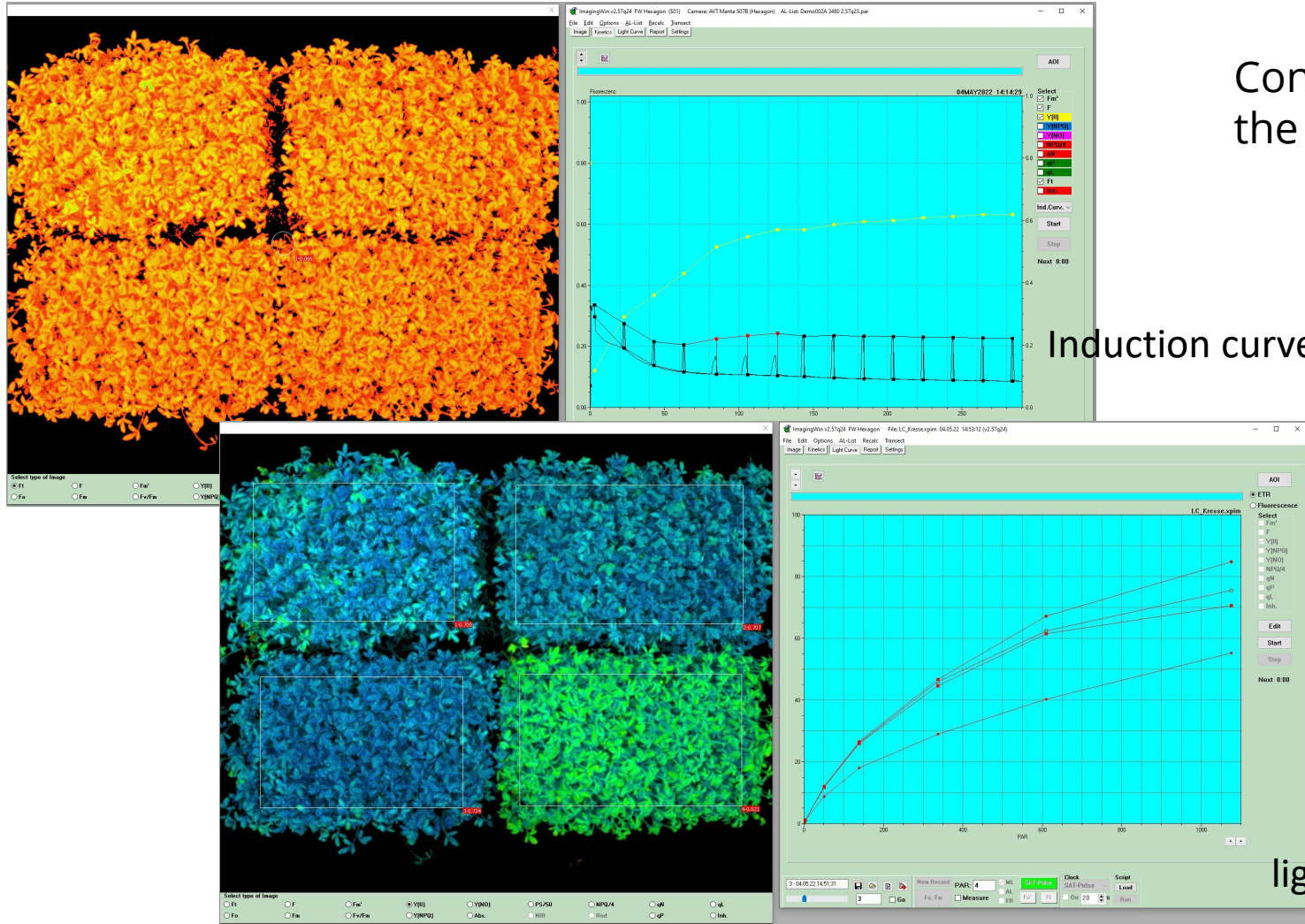

Induction curve

Convenient software workflow as known from the *m-series* imaging devices

New features:

- FR-light source implemented for Fo' measurement
- eSP method
- Float window
- 2x digital zoom function
- Tiny, specialized control computer
- 1000 x 1200 px image resolution

light curve

*For further questions on the HEXAGON-IMAGING-PAM
and chlorophyll fluorescence imaging,
please contact
Oliver Meyerhoff at Heinz Walz GmbH
(Biologist and Applications Scientist, Imaging)
omeyerhoff@walz.com*



eSP as alternative to the Sat pulse method – *available soon*

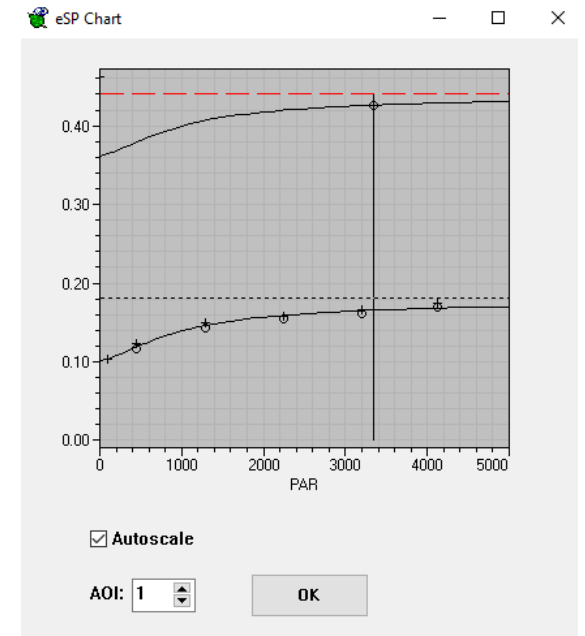
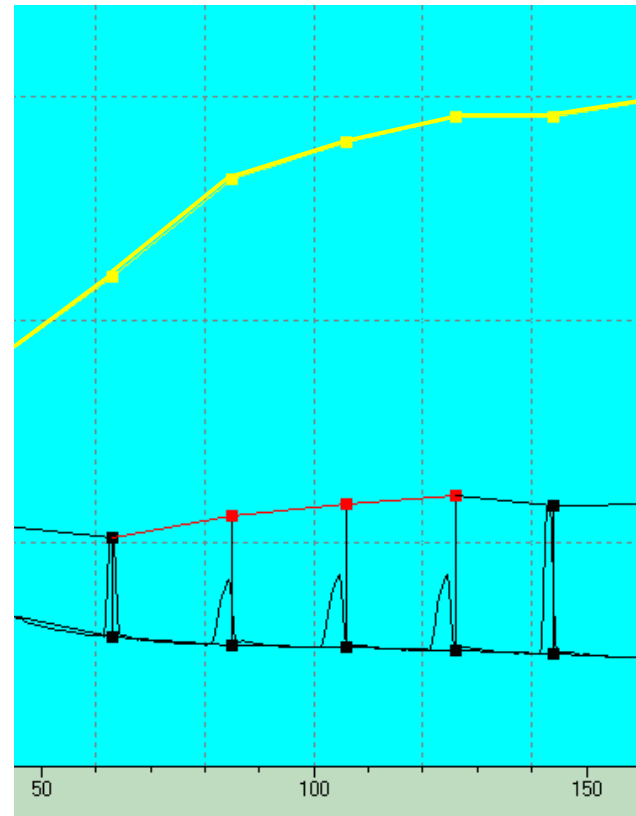
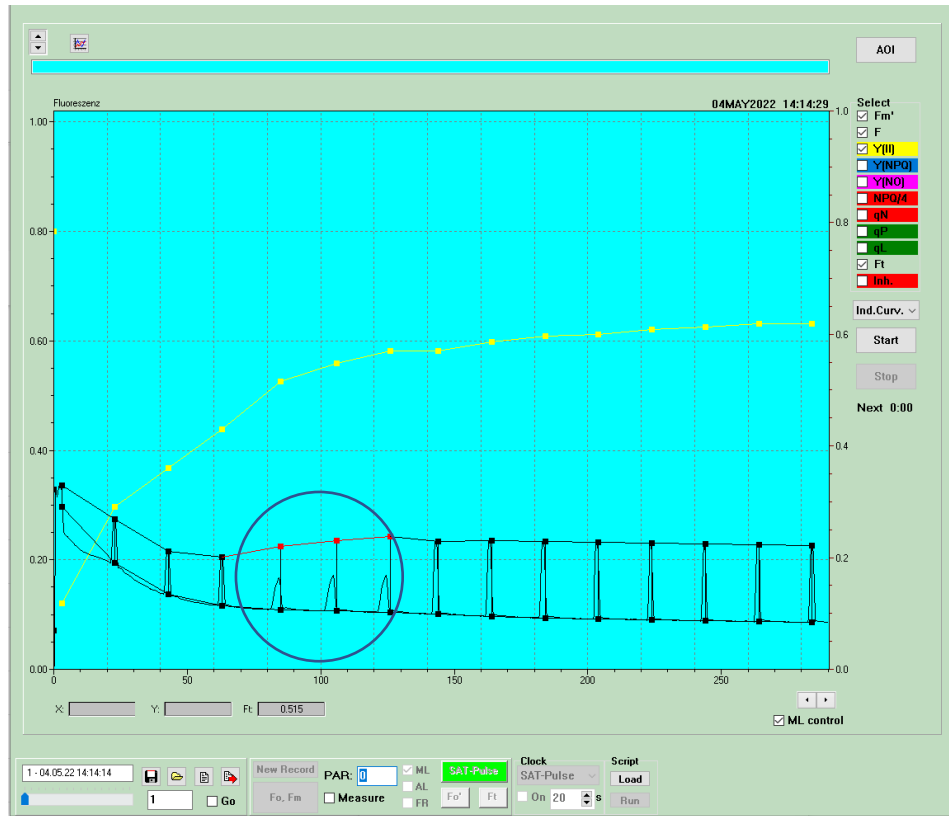

Details of eSP measurement

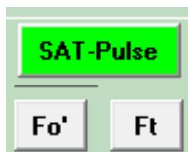

dynamically switch between the classic Sat pulse method to the new eSP method - "Left click"

